

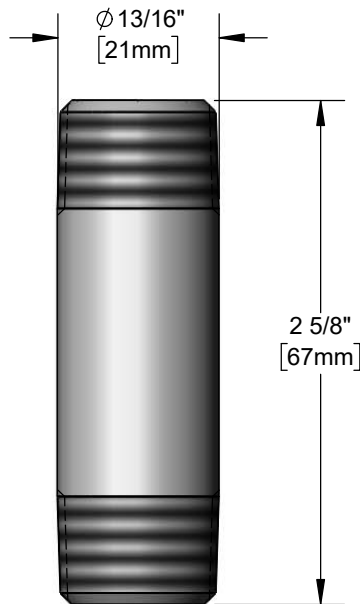

**Architect/Engineering Specifications:**

Chrome plated brass 2 5/8" Nipple with 1/2" NPT male threads. Certified to NSF 61-Section 9 and NSF 372.

Job Name \_\_\_\_\_  
 Model Specified \_\_\_\_\_ Quantity \_\_\_\_\_  
 Variations Specified \_\_\_\_\_  
 Date \_\_\_\_\_



**Features & Benefits:**

- Chrome plated 2 5/8" Nipple
- 1/2" NPT male thread (both ends)
- Material: Chrome plated brass

**Product Compliance:**

- NSF 61 - Section 9
- NSF 372 (Low Lead Content)



**Warranty:** One Year (Limited)

**Performance Data:**

- N/A

