



T&S BRASS AND BRONZE WORKS, INC.
 2 Saddleback Cove / P.O. Box 1088
 Travelers Rest, SC 29690

Model No.
B-1157-12

Item No.

Travelers Rest, SC: 800-476-4103 • Simi Valley, CA: 800-423-0150 • Fax: 864-834-3518 • www.tsbrass.com

This Space for Architect/Engineer Approval

Job Name _____ Date _____
 Model Specified _____ Quantity _____
 Customer/Wholesaler _____
 Contractor _____
 Architect/Engineer _____

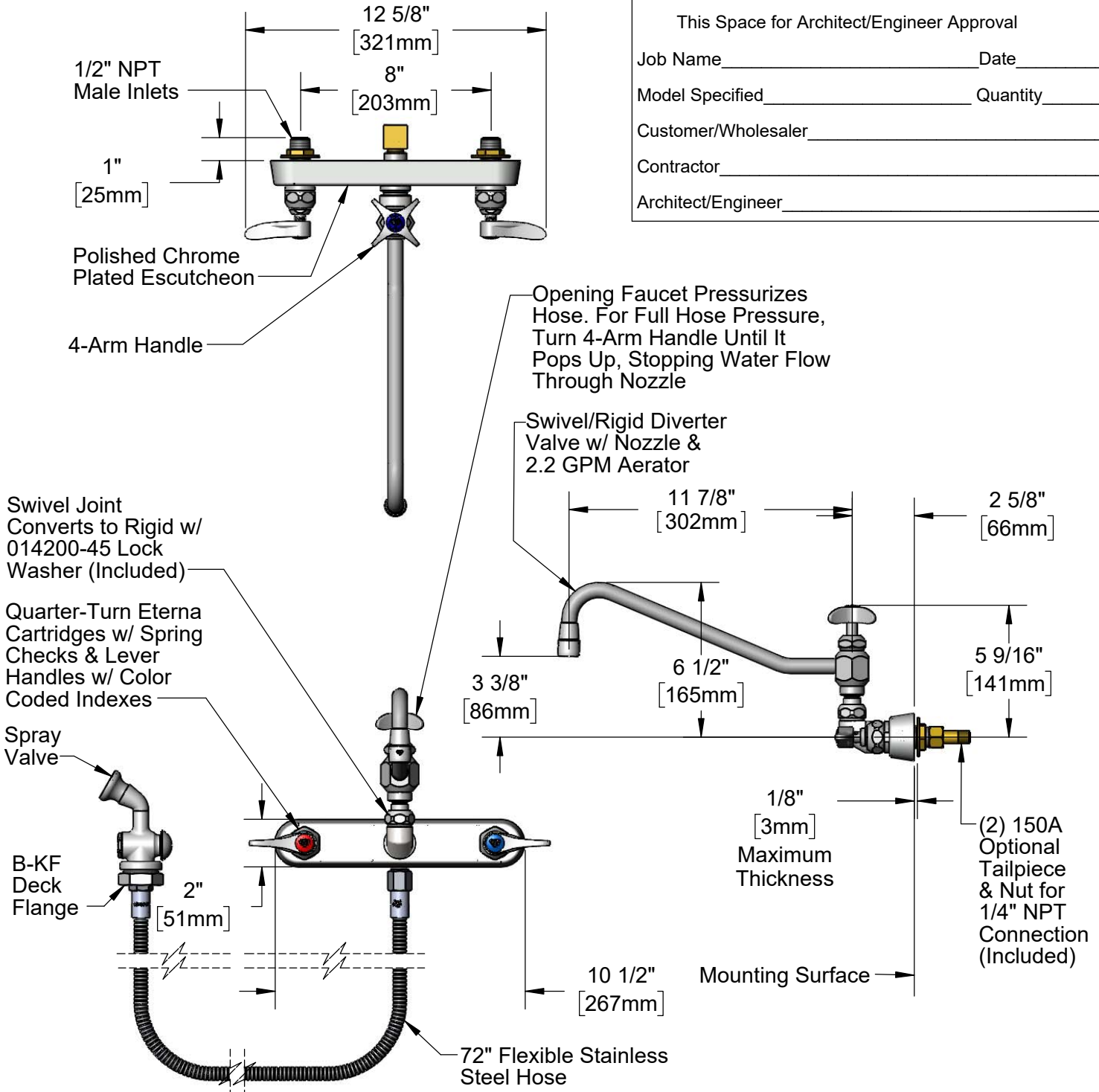

Rough-In Requirement:
 Faucet: (3) ϕ 1" [25mm] Mounting Holes
 Deck Flange: ϕ 1 9/16" [40mm] Mounting Hole

Product Specifications:
 8" Wall Mount Workboard Mixing Faucet, Quarter-Turn Eterna Cartridges w/ Spring Checks, Lever Handles, Swivel/Rigid Diverter valve w/ 11 7/8" Nozzle, 2.2 GPM Aerator, 72" Flexible Stainless Steel Hose, Spray Valve w/ 2.2 GPM Rosespray, Deck Flange & 1/2" NPT Male Inlets

Product Compliance:
 ASME A112.18.1 / CSA B125.1
 NSF 61 - Section 9
 NSF 372 (Low Lead Content)
 2019 DOE PRSV Non-Compliant



T&S BRASS AND BRONZE WORKS, INC.

2 Saddleback Cove / P.O. Box 1088
Travelers Rest, SC 29690

Model No.

B-1157-12

Item No.

Travelers Rest, SC: 800-476-4103 • Simi Valley, CA: 800-423-0150 • Fax: 864-834-3518 • www.tsbrass.com

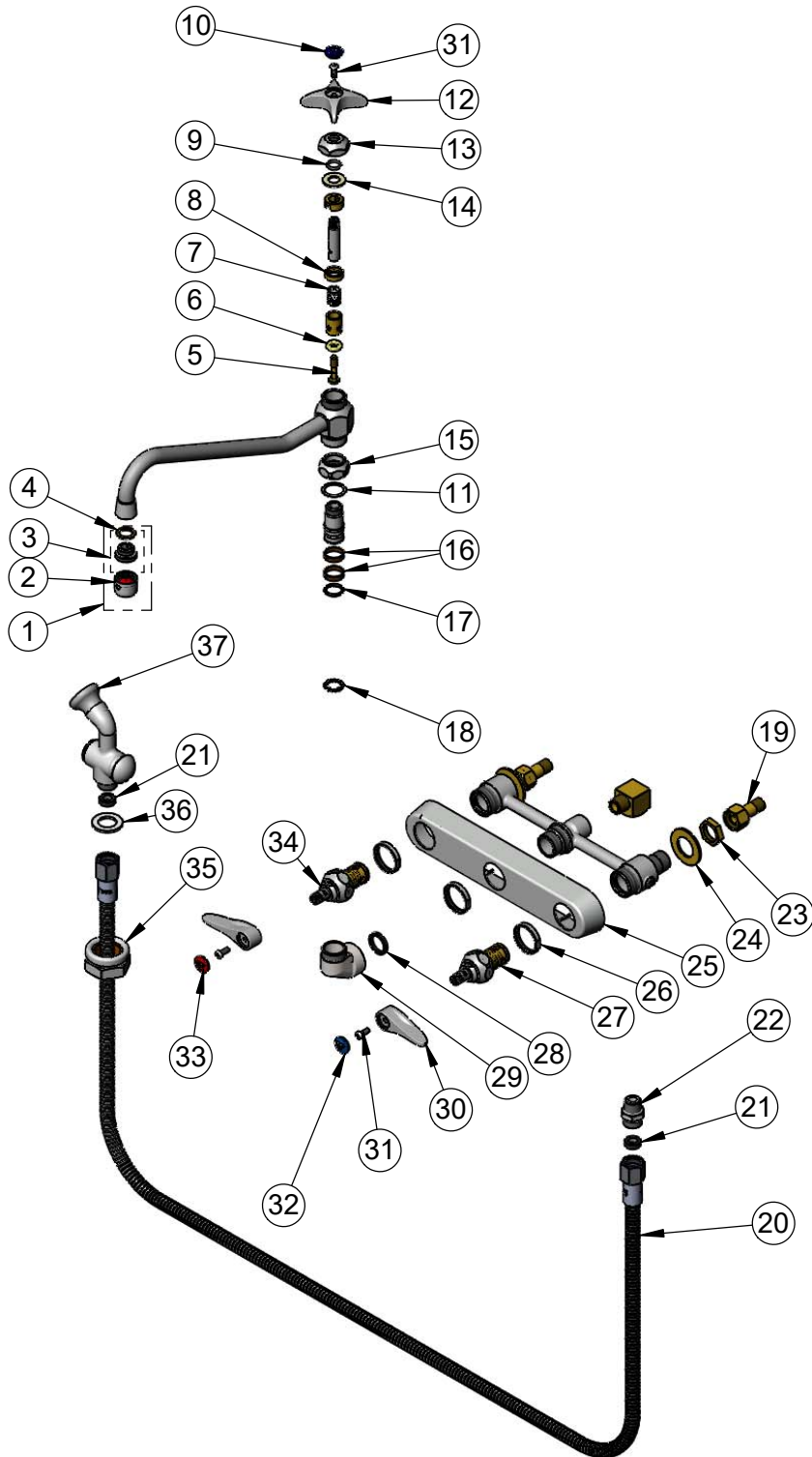

ITEM NO.	SALES NO.	DESCRIPTION
1	B-0199-02	2.2 GPM Aerator, 3/8" NPSM Male
2	B-0199-01	2.2 GPM Aerator, 55/64-27 UN Female
3	044A	3/8" to Aerator Adapter
4	001043-45	Washer
5	000832-20	Stem Diverter Bottom
6	001084-45	Seat Washer
7	000893-45	Spring
8	000875-20	Washer
9	001075-45	O-ring, Nitrile -111
10	019959-45	Press-In Diverter Index
11	009538-45	Swivel Washer
12	002521-45NS	4-Arm Handle (New Style)
13	000881-40	Bonnet Nut
14	001047-45	Washer, Santoprene
15	000711-40	Swivel Adapter Nut
16	011429-45	Swivel Sleeves (2)
17	001074-45	O-Ring
18	014200-45	Star Washer, Anti-Rotation
19	150A	1/4" NPT Tailpiece & Nut
20	013E-72H	72" Flexible Stainless Steel Hose
21	010476-45	#27 Washer
22	053A	Adapter, 3/8" NPT Male
23	002954-45	Shank Lock Nut
24	000999-45	Brass Lock Washer
25	019375-40	B-1120 Eterna Workboard Escutcheon
26	019376-40	Escutcheon Lock Nut
27	012443-40NS	Quarter-Turn New Style Eterna Cartridge w/ Spring Check, RTC
28	001040-45	Washer, 3/4 ID x 15/16 OD x 1/8 thick
29	000082-40	B-1100 Knob
30	001638-45NS	Lever Handle (New Style)
31	000925-45	Lab Handle Screw
32	018506-19NS	Blue Button Index, Press-in
33	001193-19NS	Red Button Index, Press-in
34	012442-40NS	Quarter-Turn New Style Eterna Cartridge w/ Spring Check, LTC
35	B-KF	Protective Flange
36	001010-40	Washer, Stainless Steel
37	002857-40	Spray Valve

Product Specifications:

8" Wall Mount Workboard Mixing Faucet, Quarter-Turn Eterna Cartridges w/ Spring Checks, Lever Handles, Swivel/Rigid Diverter valve w/ 1 7/8" Nozzle, 2.2 GPM Aerator, 72" Flexible Stainless Steel Hose, Spray Valve w/ 2.2 GPM Rosespray, Deck Flange & 1/2" NPT Male Inlets

Product Compliance:

ASME A112.18.1 / CSA B125.1
NSF 61 - Section 9
NSF 372 (Low Lead Content)
2019 DOE PRSV Non-Compliant