



Architect/Engineering Specifications:

Straight swivel extension with gasket and 17 5/8" overall length. Certified to ASME A112.18.1/CSA B125.1, NSF 61-Section 9 and NSF 372.

Job Name _____

Model Specified _____ Quantity _____

Variations Specified _____

Date _____

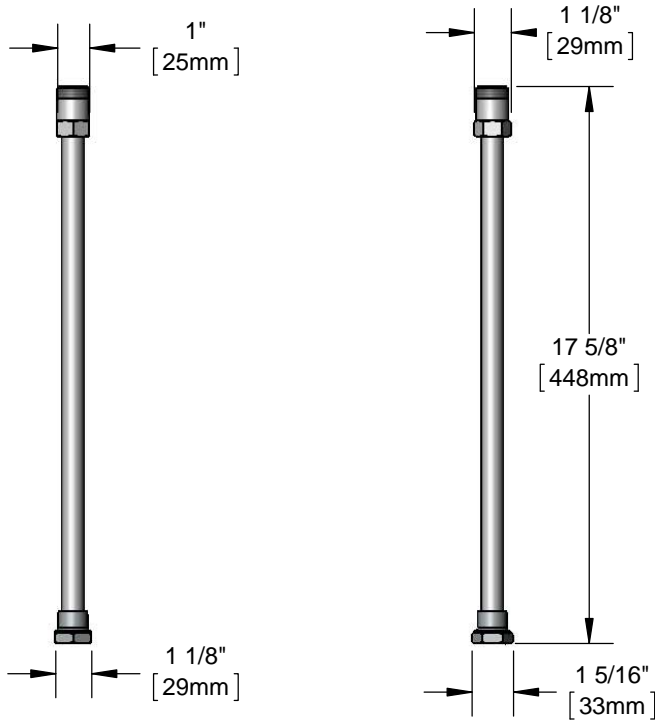

Features & Benefits:

- 17 5/8" straight swivel extension with gasket
- Fits all T&S swivel outlet faucets
- Material: Chrome plated brass

Product Compliance:

- ASME A112.18.1 / CSA B125.1
- NSF 61 - Section 9
- NSF 372 (Low Lead Content)



Warranty: One Year (Limited)



Performance Data:

- N/A

