



#### Architect/Engineering Specifications:

10" high deck mount glass filler with polished chrome plated brass body, adjustable flow outlet, push back actuation arm, pedestal with adjustable deck flange, water filtration cartridge and 1/2" NPT male inlet. Certified to ASME A112.18.1/CSA B125.1, NSF 61-Section 9 and NSF 372. Meets ADA ANSI/ICC A117.1 requirements.

Job Name \_\_\_\_\_

Model Specified \_\_\_\_\_ Quantity \_\_\_\_\_

Variations Specified \_\_\_\_\_

Date \_\_\_\_\_

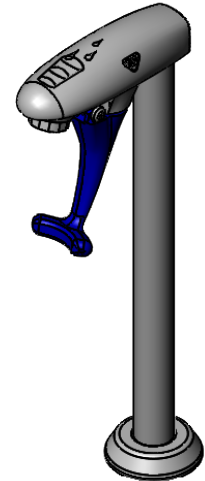
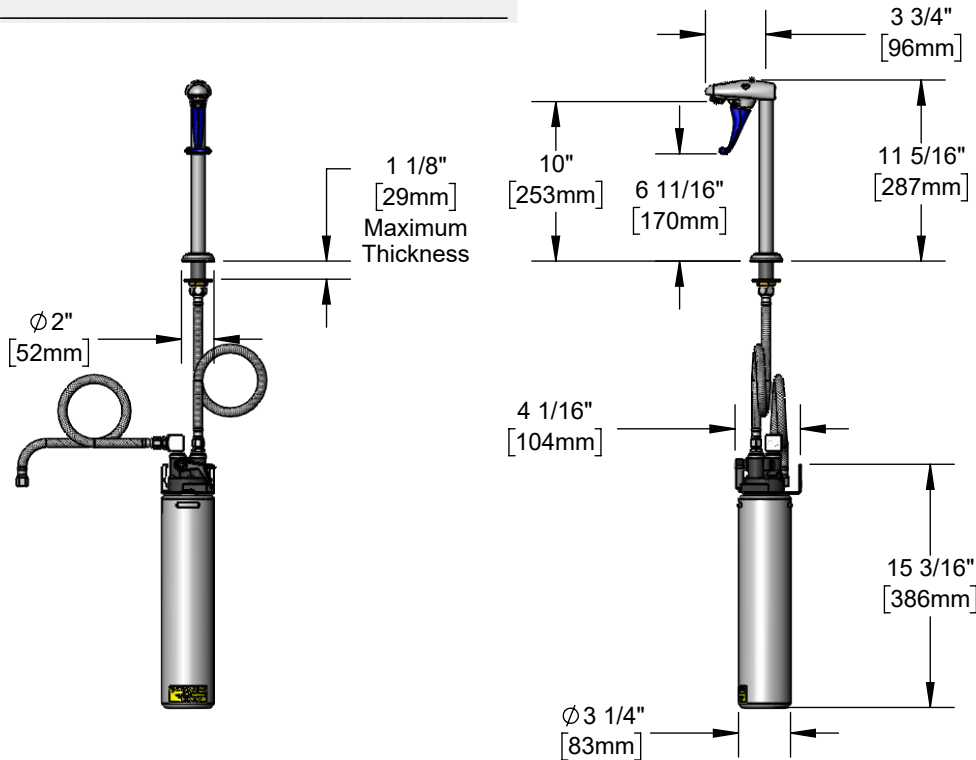

#### Features & Benefits:

- 10" high deck mount glass filler
- Torx wrench adjustable flow outlet (wrench included)
- Dark blue push back arm
- Instantaneous shut-off
- 1/2" NPT male inlet
- Pedestal w/ adjustable  $\varnothing$  2" flange
- Replacement water filtration cartridge & docking station
- Material: polished chrome plated brass body & pedestal, chrome plated metal flange and thermoplastic arm

#### Product Compliance:

- ASME A112.18.1 / CSA B125.1
- NSF 61 - Section 9
- NSF 372 (Low Lead Content)
- ANSI A117.1 (ADA)

**Warranty:** One Year (Limited)

#### Performance Data:

- Pressure: 20 - 125 psi [1.38 - 8.62 BAR]
- Temperature: 40°F - 140°F [4.44°C - 60°C]
- Flow Rate: 0.25 GPM [0.95 L/min] min @ 60 psi [4.14 bar]  
2.25 GPM [8.52 L/min] max @ 60 psi [4.14 bar]



ADA Compliant

