



Architect/Engineering Specifications:

12" swing nozzle with stream regulator outlet. Certified to ASME A112.18.1/CSA B125.1, NSF 61-Section 9 and NSF 372.

Job Name \_\_\_\_\_

Model Specified \_\_\_\_\_ Quantity \_\_\_\_\_

Variations Specified \_\_\_\_\_

Date \_\_\_\_\_

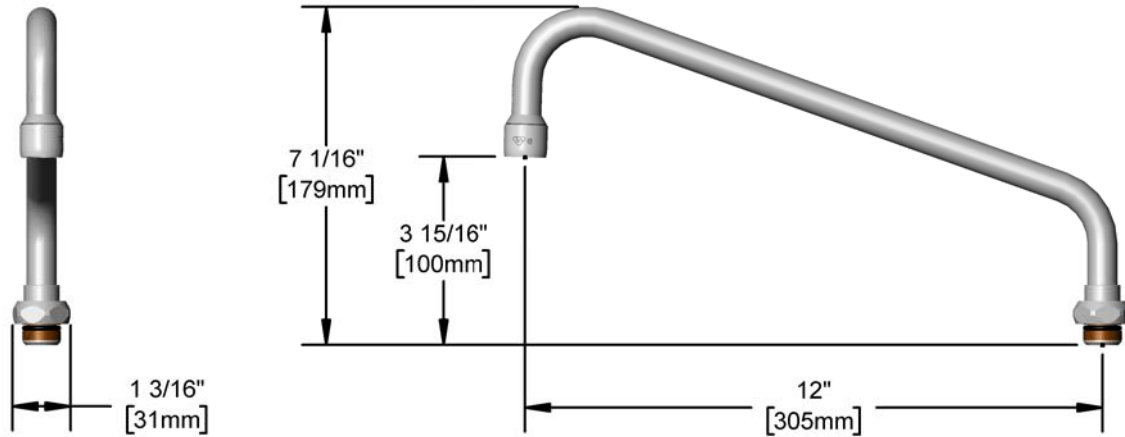

Features & Benefits:

- 12" swing nozzle
- B-PT stream regulator outlet, Series 1
- Fits all T&S swivel outlet faucets
- Material: Chrome plated brass tubular spout

Product Compliance:

- ASME A112.18.1 / CSA B125.1
- NSF 61 - Section 9
- NSF 372 (Low Lead Content)



Warranty: One Year (Limited)

Performance Data:

- Pressure: 20 - 125 psi
- Temperature: 40°F - 140°F
- Flow Rate: 26.30 GPM @ 60 psi

