



# Epoxy Coated Retractable Hose Reel

## B-7212-01-ESB

TAG:

### Open Epoxy Coated Hose Reel

#### Architect/Engineering Specifications:

Open epoxy coated steel hose reel, high flow spray valve with swivel, 3/8" x 15' heavy-duty non-marking hose, ratcheting system, multi-fit bracket, adjustable hose bumper, 3/8" NPT female inlet and universal stainless steel wall mount swing bracket with reel-to-bracket mounting hardware.

Job Name \_\_\_\_\_  
 Model Specified \_\_\_\_\_ Quantity \_\_\_\_\_  
 Variations Specified \_\_\_\_\_  
 Date \_\_\_\_\_

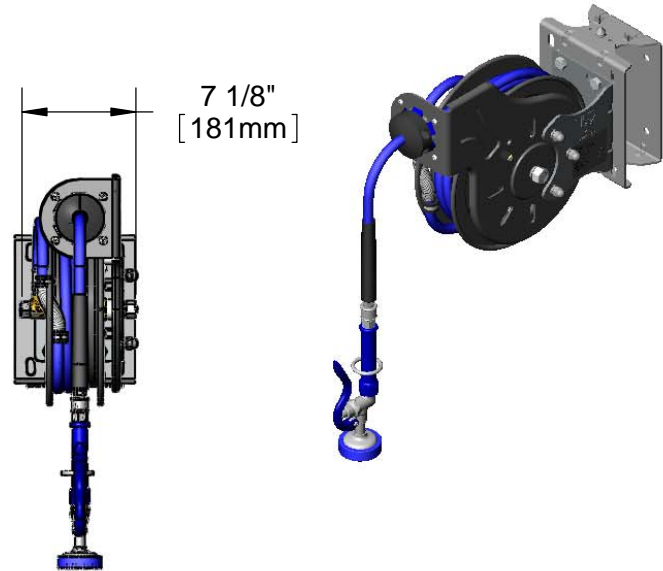
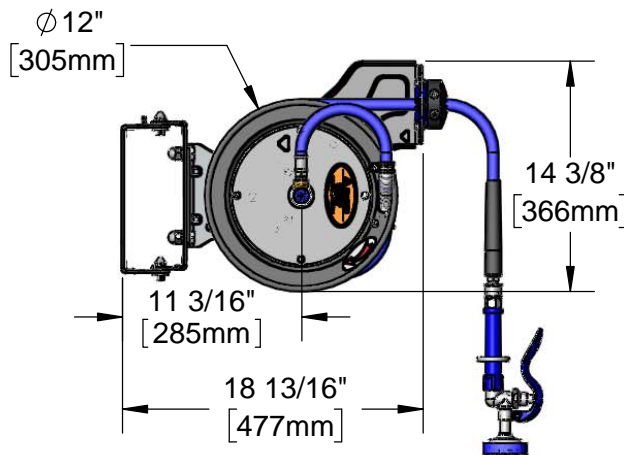

#### Features & Benefits:

- Open epoxy coated steel hose reel
- Blue high flow spray valve w/ swivel
- 3/8" x 15' heavy-duty non-marking hose rated to 300 PSI
- Ratcheting system holds the length of hose until a slight tug to retract automatically
- 3/8" NPT female inlet
- Adjustable hose bumper
- Multi-fit bracket for wall, ceiling or under counter mounting
- 100 degree universal stainless steel wall mount swing bracket designed for one person installation with reel-to-bracket mounting hardware
- Material: Epoxy coated steel open reel and wall bracket, polished chrome plated spray valve, stainless steel swing bracket

#### Product Compliance:

- NSF 61 Exempt (Non-Potable)
- EPA Act 2005 Non-Compliant (PRSV)

#### Warranty: Two Year (Limited)

- Hose: One Year (Limited)

#### Performance Data:

- Pressure: 20 - 125 psi
- Temperature: 40 °F - 140 °F
- Flow Rate: 3.70 GPM @ 60 psi

#### Optional Hose Reel Spray Valves

- B-0107 Med Flow Spray Valve
- B-0108 Ergonomic Medium Flow Spray Valve
- B-0108-H Ergonomic High Flow Spray Valve
- EB-0107 High Flow Spray Valve (Standard)
- EB-2322 Extended Spray Wand
- MV-2516-24 Stainless Steel Rear Trigger Water Gun
- MV-2522-24 Stainless Steel Front Trigger Water Gun
- MV-3516-24 Aluminum Rear Trigger Water Gun

#### Optional Hose Reel Multi-Fit Brackets

##### 3/8" x 15', 30', & 35' Epoxy Coated Hose Reel

- G019430-45 EasyInstall Stainless Steel Swing Bracket (Standard)
- G016636-45 Epoxy Coated Wall Swing Bracket
- G016652-45 Deck Mount Pivot Bracket
- G018477-45 Stainless Steel Table Leg Swing Bracket



T&S BRASS AND BRONZE WORKS, INC.



• 2 Saddleback Cove • Travelers Rest, SC 29690  
 Ph 800-476-4103 • Fax 864-834-3518  
 • Simi Valley, CA • Ph 800-423-0150 • www.tsbrass.com

Date: 10/09/17