

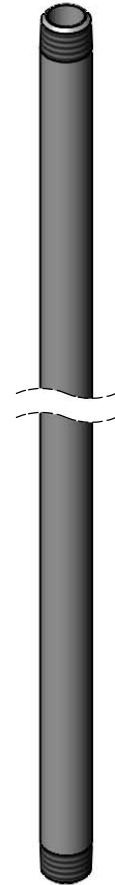

Architect/Engineering Specifications:

Polished chrome plated brass 28" riser with 3/8" NPT male threads. Certified to NSF 61-Section 9 and NSF 372.

Job Name \_\_\_\_\_  
 Model Specified \_\_\_\_\_ Quantity \_\_\_\_\_  
 Variations Specified \_\_\_\_\_  
 Date \_\_\_\_\_

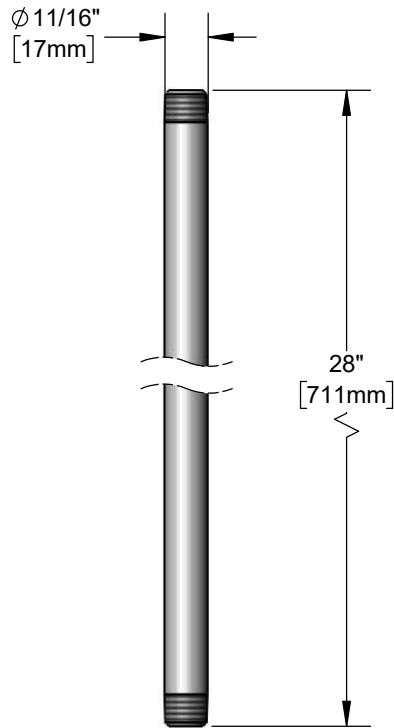

Features & Benefits:

- 28" riser
- 3/8" NPT male threads
- Material: Polished chrome plated brass

Product Compliance:

- NSF 61 - Section 9
- NSF 372 (Low Lead Content)



Warranty: One Year (Limited)

Performance Data:

- N/A

