



Architect/Engineering Specifications:

Angle slip flange for 3/4" NPT pipe, with polished chrome plated brass body.

Job Name _____

Model Specified _____ Quantity _____

Variations Specified _____

Date _____

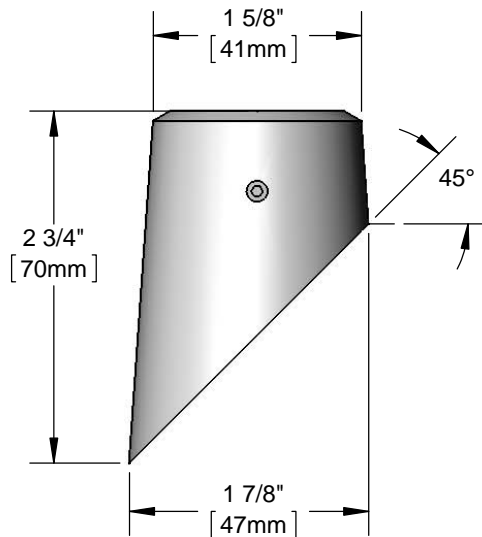
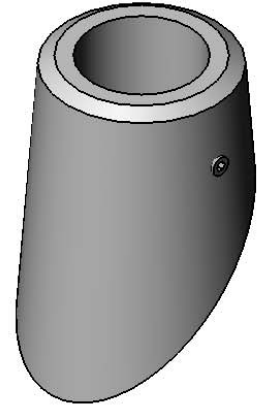

Features & Benefits:

- Angle slip flange, for 3/4" NPT pipe
- Pipe must be held rigid under with with connection fittings, brace, etc.
- Material: Polished chrome plated brass body

Product Compliance:

- N/A

Warranty: One Year (Limited)

Performance Data:

- N/A

