



T&S BRASS AND BRONZE WORKS, INC.

2 Saddleback Cove / P.O. Box 1088
Travelers Rest, SC 29690

Model No.

B-0409-03

Item No.

Travelers Rest, SC: 800-476-4103 • Simi Valley, CA: 800-423-0150 • Fax: 864-834-3518 • www.tsbrass.com

This Space for Architect/Engineer Approval

Job Name _____ Date _____

Model Specified _____ Quantity _____

Customer/Wholesaler _____

Contractor _____

Architect/Engineer _____



Ø 1 11/16"
[43mm]



9" Swing Nozzle w/
B-GH
Garden Hose
Adapter Outlet

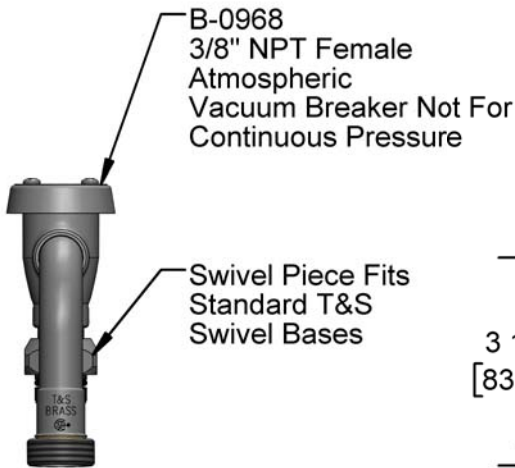

B-0968
3/8" NPT Female
Atmospheric
Vacuum Breaker Not For
Continuous Pressure

Swivel Piece Fits
Standard T&S
Swivel Bases

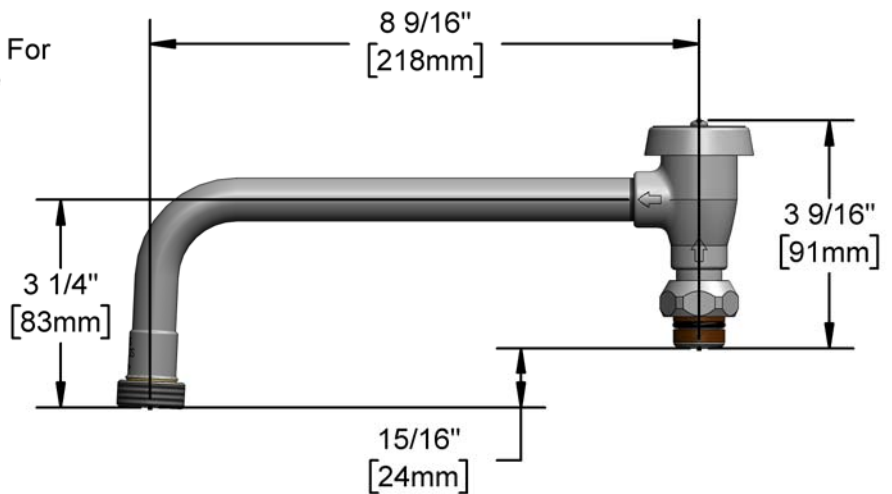

Product Specifications:

Vacuum Breaker Swing Nozzle, Garden Hose Adapter Outlet and Swivel Base Inlet

Product Compliance:

ASME A112.18.1 / CSA B125.1
NSF 61 - Section 9
NSF 372 (Low Lead Content)
ASSE 1001 (VB)



T&S BRASS AND BRONZE WORKS, INC.

2 Saddleback Cove / P.O. Box 1088
Travelers Rest, SC 29690

Model No.

B-0409-03

Item No.

Travelers Rest, SC: 800-476-4103 • Simi Valley, CA: 800-423-0150 • Fax: 864-834-3518 • www.tsbrass.com

ITEM NO.	SALES NO.	DESCRIPTION
1	B-GH	Adapter 3/4" GH X 3/8" NPSM
2	001043-45	Washer
3	B-0968	3/8" NPT Vacuum Breaker
4	009538-45	Swivel Washer
5	011429-45	Swivel Sleeves (2)
6	001074-45	O-Ring
7	017X	8" Vacuum Breaker Nozzle

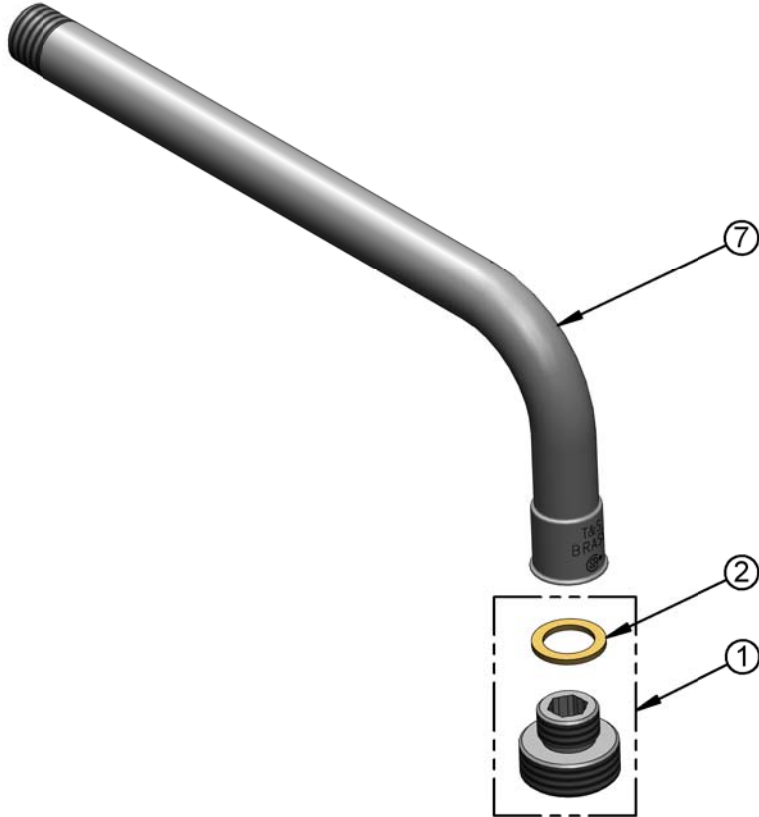
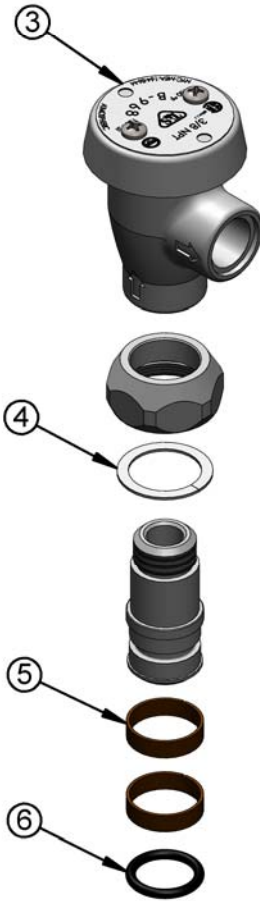

Product Specifications:

Vacuum Breaker Swing Nozzle, Garden Hose Adapter Outlet and Swivel Base Inlet

Product Compliance:

ASME A112.18.1 / CSA B125.1
NSF 61 - Section 9
NSF 372 (Low Lead Content)
ASSE 1001 (VB)