

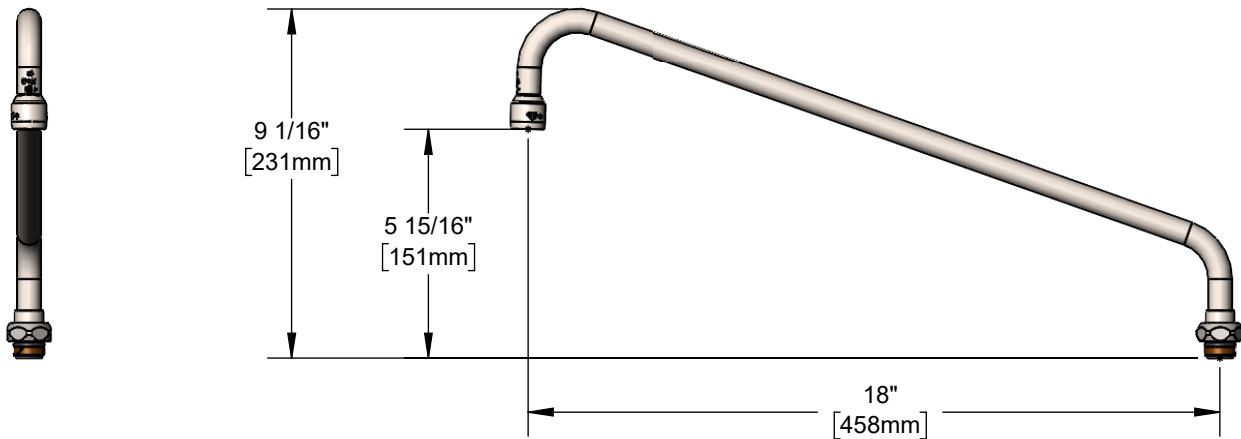

Architect/Engineering Specifications:

Stainless steel 18" swing nozzle with stream regulator outlet. Certified to ASME A112.18.1/CSA B125.1, NSF 61-Section 9 and NSF 372.

Job Name _____
 Model Specified _____ Quantity _____
 Variations Specified _____
 Date _____

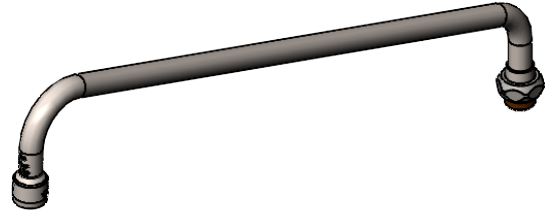

Features & Benefits:

- 18" swing nozzle
- S-PT stream regulator outlet
- Fits all T&S stainless steel swivel outlet faucets
- Material: Stainless steel tubular spout

Product Compliance:

- ASME A112.18.1 / CSA B125.1
- NSF 61 - Section 9
- NSF 372 (Low Lead Content)



Warranty: One Year (Limited)

Performance Data:

- Pressure: 20 - 125 psi [1.38 - 8.62 bar]
- Temperature: 40°F - 140°F [4.44°C - 60°C]
- Flow Rate: 26.30 GPM [99.56 l/min] @ 60 psi [4.14 bar]

