



Swivel Sink and Pantry Faucets

B-0202-CR

TAG:

Double Pantry Faucet

Architect/Engineering Specifications:

Single hole deck mount mixing faucet with polished chrome plated brass body, 6" swing nozzle with stream regulator outlet, ceramic cartridges with check valves, lever handles and 18" flexible stainless steel supply hoses with 1/2" NPSM / 5/8" O.D. compression connections. ASME A112.18.1 / CSA B125.1, NSF 61-Section 9 and NSF 372. Meets ADA ANSI/ICC A117.1 requirements.

Job Name _____
 Model Specified _____ Quantity _____
 Variations Specified _____
 Date _____

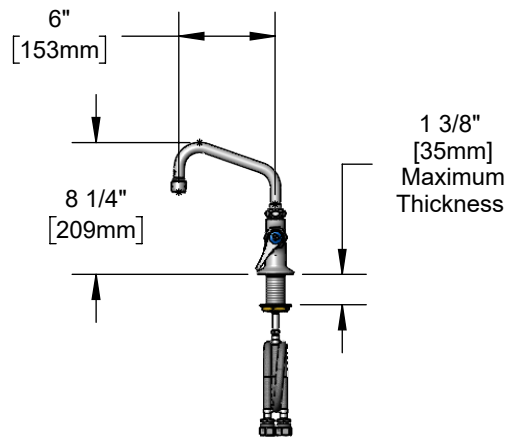
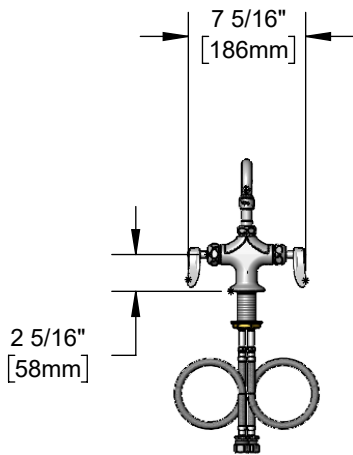

Features & Benefits:

- Single hole deck mount mixing faucet w/ polished chrome plated brass body
- 6" swing nozzle
- Lock washer provided for rigid application
- Stream regulator outlet, Series 1
- Quarter-turn Cerama cartridges w/ check valves to prevent cross flow of water
- Lever handles w/ color coded indexes
- 18" flexible stainless steel supply hoses w/ 1/2" NPSM / 5/8" O.D. compression connections
- Material: Polished chrome plated brass body & tubular spout and polished chrome metal handles

Product Compliance:

- ASME A112.18.1 / CSA B125.1
- NSF 61 - Section 9
- NSF 372 (Low Lead Content)
- ANSI A117.1 (ADA)



Warranty: One Year (Limited)

- Cerama Cartridge: Lifetime (Limited)

Performance Data:

- Pressure: 20 - 125 psi [1.38 - 8.62 bar]
- Temperature: 40°F - 140°F [4.44°C - 60°C]
- Flow Rate: 7.44 GPM [28.2 L/min] @ 60 psi [4.14 bar]



ADA Compliant

Optional Outlets (Series 1 / VR Series 6)

GPM	Aerated	Non-Aerated (Laminar)	VR Aerated	VR Non-Aerated (VR Laminar)
0.35	N/A	<input type="checkbox"/> B-0199-01-N035	N/A	<input type="checkbox"/> B-0199-06-N035
0.5	N/A	<input type="checkbox"/> B-0199-01-N05	N/A	<input type="checkbox"/> B-0199-06-N05
1.0	<input type="checkbox"/> B-0199-01-F10	N/A	<input type="checkbox"/> B-0199-06-F10	N/A
1.2	<input type="checkbox"/> B-0199-01-F12	<input type="checkbox"/> B-0199-01-LF12	<input type="checkbox"/> B-0199-06-F12	<input type="checkbox"/> B-0199-06-LF12
1.5	<input type="checkbox"/> B-0199-01-WS	<input type="checkbox"/> B-0199-29	<input type="checkbox"/> B-0199-06-WS	<input type="checkbox"/> B-0199-29VR
2.2	<input type="checkbox"/> B-0199-01	<input type="checkbox"/> B-0199-21	<input type="checkbox"/> B-0199-06	<input type="checkbox"/> B-0199-21-VRF

Optional Handles

- 4" Wrist Action
- Lever (Standard)
- 4-Arm

Optional Cartridges With Checks

- Quarter-Turn Cerama w/ Check Valve (Standard)
- Quarter-Turn Eterna w/ Spring Check



T&S BRASS AND BRONZE WORKS, INC.



• 2 Saddleback Cove • Travelers Rest, SC 29690
 Ph 800-476-4103 • Fax 864-834-3518
 • Simi Valley, CA • Ph 800-423-0150 • www.tsbrass.com

Date: 09/28/23