



T&S BRASS AND BRONZE WORKS, INC.

2 Saddleback Cove / P.O. Box 1088
Travelers Rest, SC 29690

Model No.

ECW-3163-BN-HG

Item No.

Travelers Rest, SC: 800-476-4103 • Simi Valley, CA: 800-423-0150 • Fax: 864-834-3518 • www.tsbrass.com

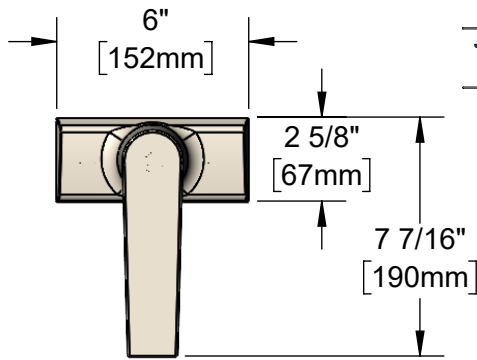

WAVECREST™
BY T&S



ADA Compliant

This Space for Architect/Engineer Approval

Job Name _____ Date _____

Model Specified _____ Quantity _____

Customer/Wholesaler _____

Contractor _____

Architect/Engineer _____

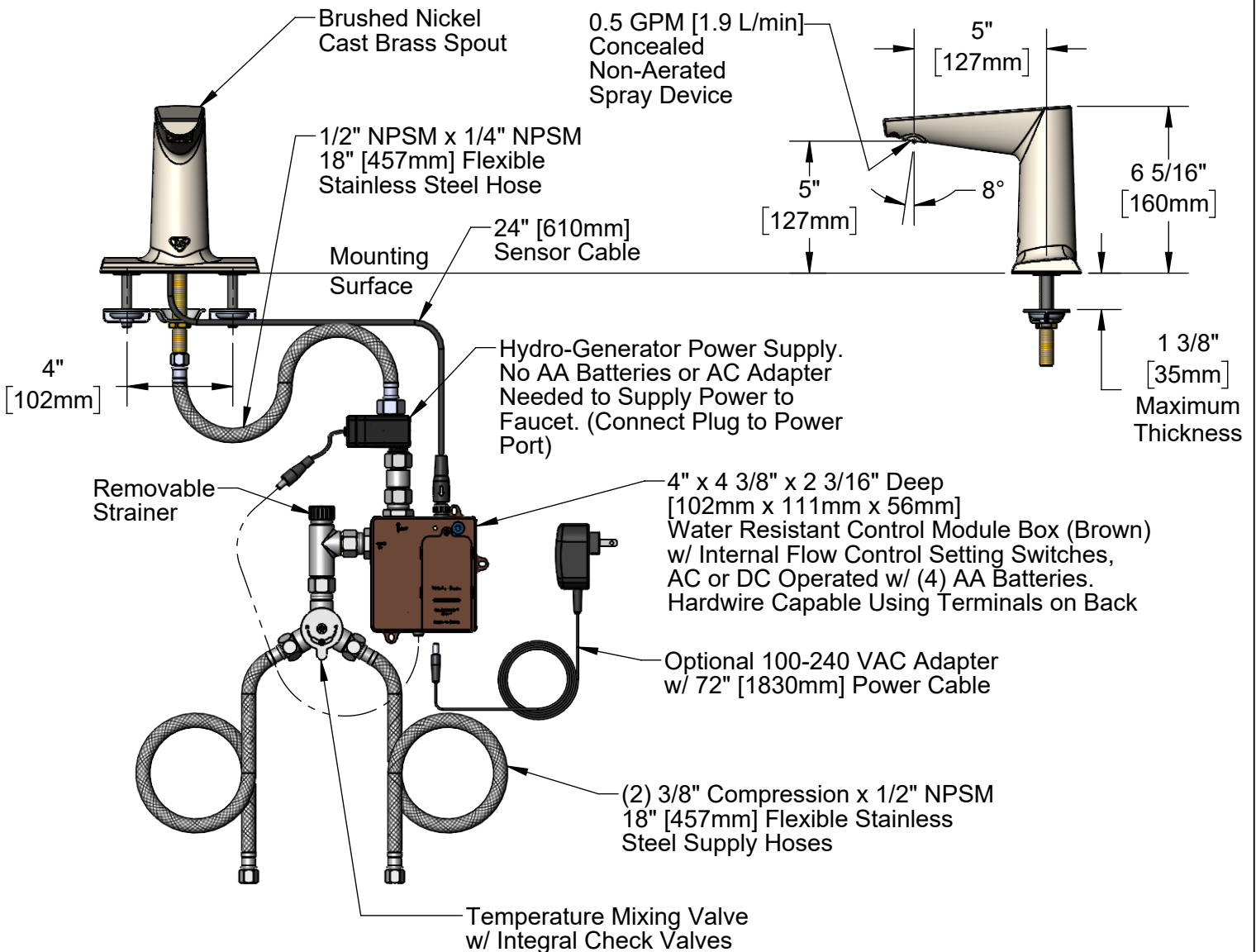

Product Specifications:
Brushed Nickel Brass Electronic Faucet: 4" Centerset Deck Mount, Cast Spout w/ 0.5 GPM Concealed Non-Aerated Spray Device, AC/DC Control Module w/ Internal Flow Control Setting Switches, Temperature Control Mixing Valve w/ Integral Check Valves, Hydro-Generator & 18" Hot & Cold Supply Stop Flexible Connector Hoses

Product Compliance:
ASME A112.18.1 / CSA B125.1
NSF 61 - Section 9
NSF 372 (Low Lead Content)
ANSI A117.1 (ADA)
UL 1951



T&S BRASS AND BRONZE WORKS, INC.

2 Saddleback Cove / P.O. Box 1088
Travelers Rest, SC 29690

Model No.

ECW-3163-BN-HG

Item No.

Travelers Rest, SC: 800-476-4103 • Simi Valley, CA: 800-423-0150 • Fax: 864-834-3518 • www.tsbrass.com

ITEM NO.	SALES NO.	DESCRIPTION
1	020755-45	Straight Hidden Sensor w/ Screw
2	B-0199-M21-V05	0.5 GPM Concealed Spray Device, M21.5 x 1
3	020674-45	M21.5 x 1 Red Cache Key
4	016297-45	Inlet Hose, Faucet, 1/2" NPSM-F x 1/4" NPSM-F
5	EC-FILTER	Replacement Filter
6	5EF-0006	Temperature Mixing Valve
7	5EF-0005	Supply Hose, 9/16-24 Female x 1/2" NPSM
8	020754-45	WaveCrest Sensor Cable
9	EC-HYDROGEN-LF	Low Flow Hydrogenerator
10	020744-45	WaveCrest Control Module w/ Filter Tee
11	5EF-0002C	AC Adapter - US Plug

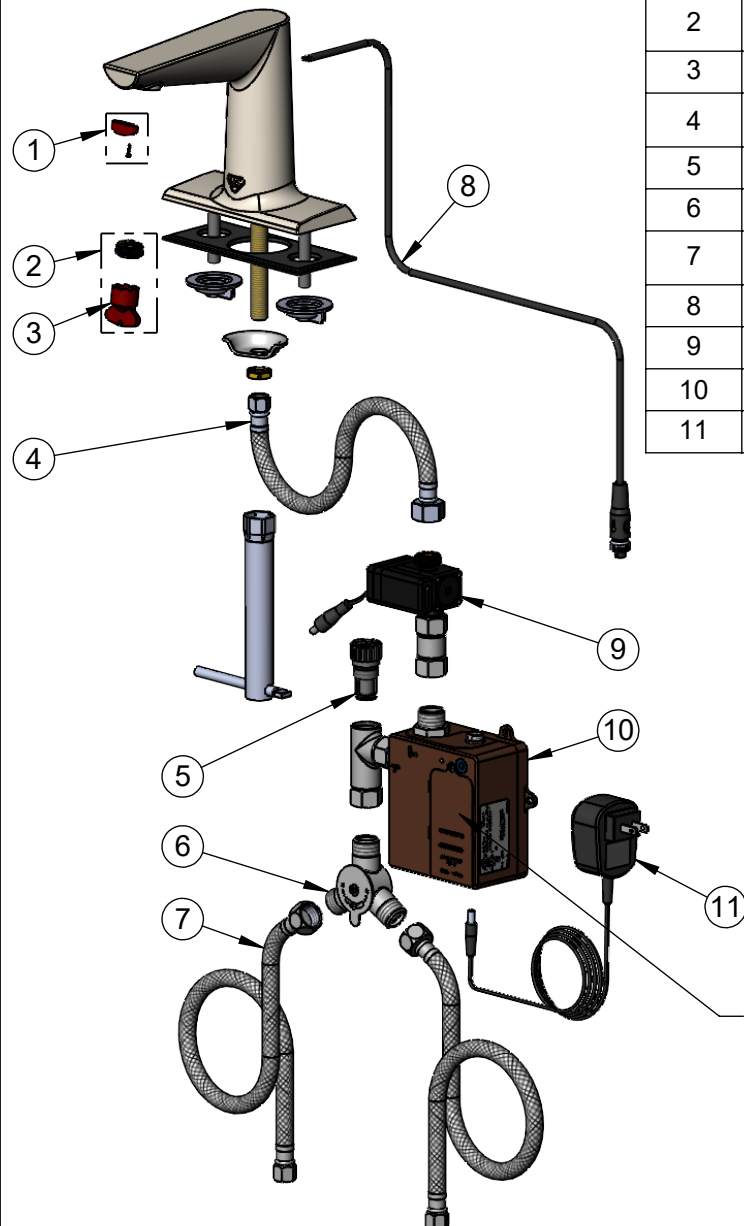

A Maximum of (8) ChekPoint Faucets can be Hardwire Connected and Powered by EC-HARDWIRE ChekPoint Hardwire AC Transformer. (Sold Separately)

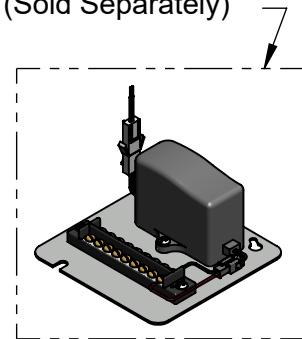

Flow Control Switches are Located Behind Battery Compartment Cover.
* Switches are Set to DEFAULT Position:
- Auto Time Out = 15 Seconds
- Shut Off Delay = 1 Second
- Auto Flush = OFF
- Metering Mode = OFF

*** Available Water Flow Control Selections:**

- Auto Time Out: 15 sec, 30 sec, 45 sec, 60 sec, 3 min, 20 min
- Shut Off Delay: 1 sec, 10 sec, 15 sec, 30 sec
- Auto Flush (30 Seconds After Every 12 Inactive Hours): ON or OFF
- Metering Mode: ON or OFF

Product Specifications:
Brushed Nickel Brass Electronic Faucet: 4" Centerset Deck Mount, Cast Spout w/ 0.5 GPM Concealed Non-Aerated Spray Device, AC/DC Control Module w/ Internal Flow Control Setting Switches, Temperature Control Mixing Valve w/ Integral Check Valves, Hydro-Generator & 18" Hot & Cold Supply Stop Flexible Connector Hoses

Product Compliance:
ASME A112.18.1 / CSA B125.1
NSF 61 - Section 9
NSF 372 (Low Lead Content)
ANSI A117.1 (ADA)
UL 1951