

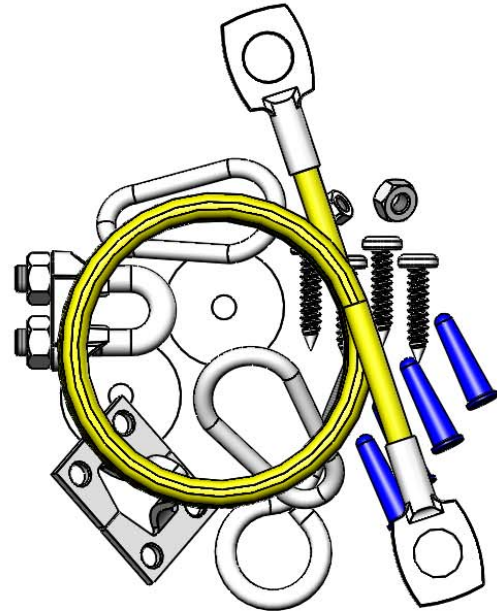

Architect/Engineering Specifications:

Restraining cable kit with mounting hardware, 1/2" NPT 90° elbow and 1/2" NPT ball valve. Certified to ANSI Z21.15a/CSA 9.1a.

Job Name _____
 Model Specified _____ Quantity _____
 Variations Specified _____
 Date _____

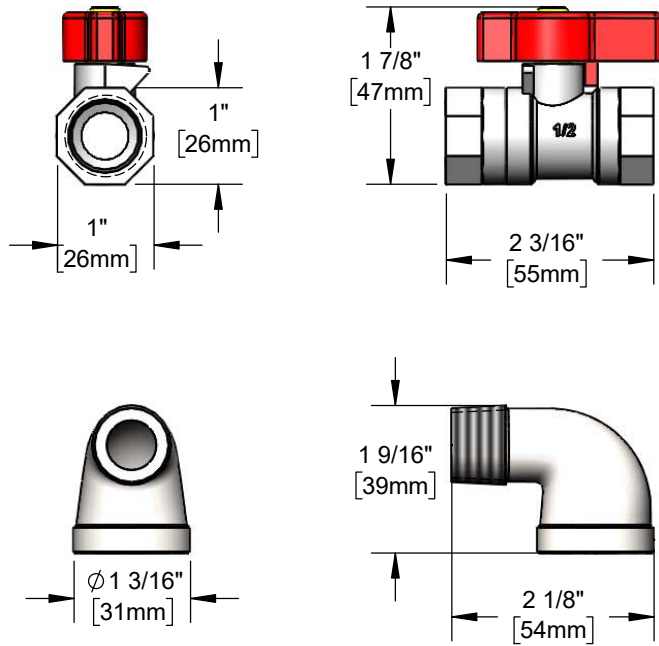

Features & Benefits:

- Restraining cable kit with mounting hardware
- 1/2" NPT 90° elbow
- 1/2" NPT ball valve
- Optimum torsional relief improves safety, increases connector life
- Material: Chrome plated brass valve and elbow and steel restraining cable

Product Compliance:

- ANSI Z21.15a / CSA 9.1a (Gas Valves)
- NFPA 54

Warranty: Five Year (Limited)

Performance Data:

- Gas Pressure: 1/2 psi max
- Temperature: 350 °F max
- Capacity: 140,000 BTU / hr min

