

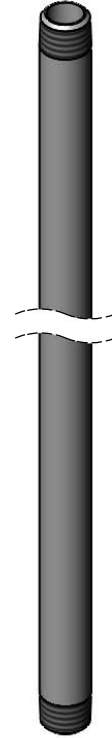

Architect/Engineering Specifications:

Polished chrome plated brass 32" riser with 3/8" NPT male threads. Certified to NSF 61-Section 9 and NSF 372.

Job Name _____
 Model Specified _____ Quantity _____
 Variations Specified _____
 Date _____

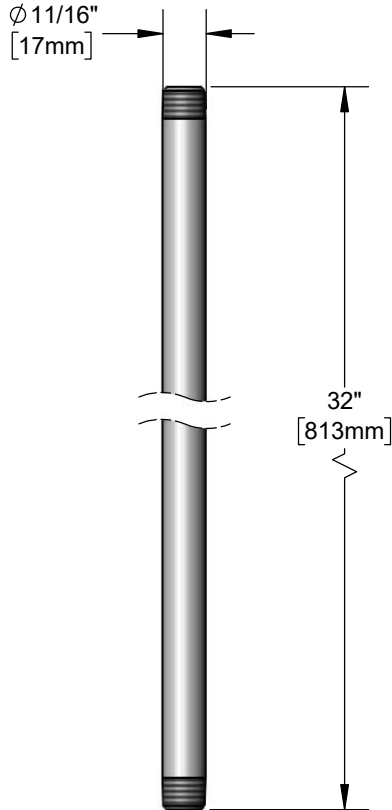

Features & Benefits:

- 32" riser
- 3/8" NPT male threads
- Material: Polished chrome plated brass

Product Compliance:

- NSF 61 - Section 9
- NSF 372 (Low Lead Content)



Warranty: One Year (Limited)

Performance Data:

- N/A

