



T&S BRASS AND BRONZE WORKS, INC.
 2 Saddleback Cove / P.O. Box 1088
 Travelers Rest, SC 29690

Model No.
SMPM-2DLN-08

Item No.

Travelers Rest, SC: 800-476-4103 • Simi Valley, CA: 800-423-0150 • Fax: 864-834-3518 • www.tsbrass.com

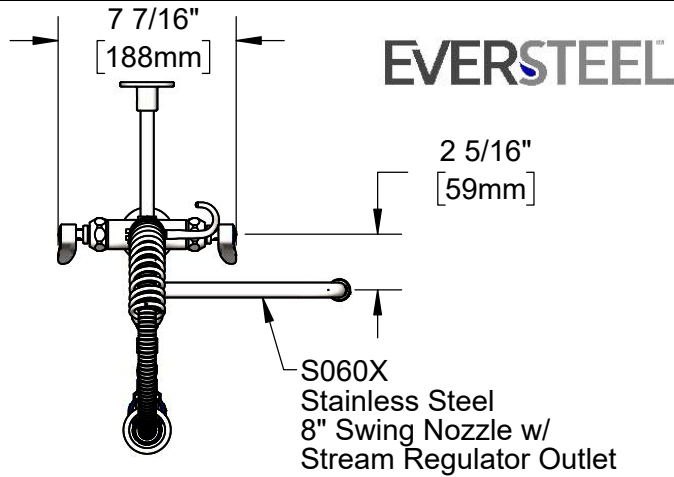

This Space for Architect/Engineer Approval

Job Name _____ Date _____

Model Specified _____ Quantity _____

Customer/Wholesaler _____

Contractor _____

Architect/Engineer _____

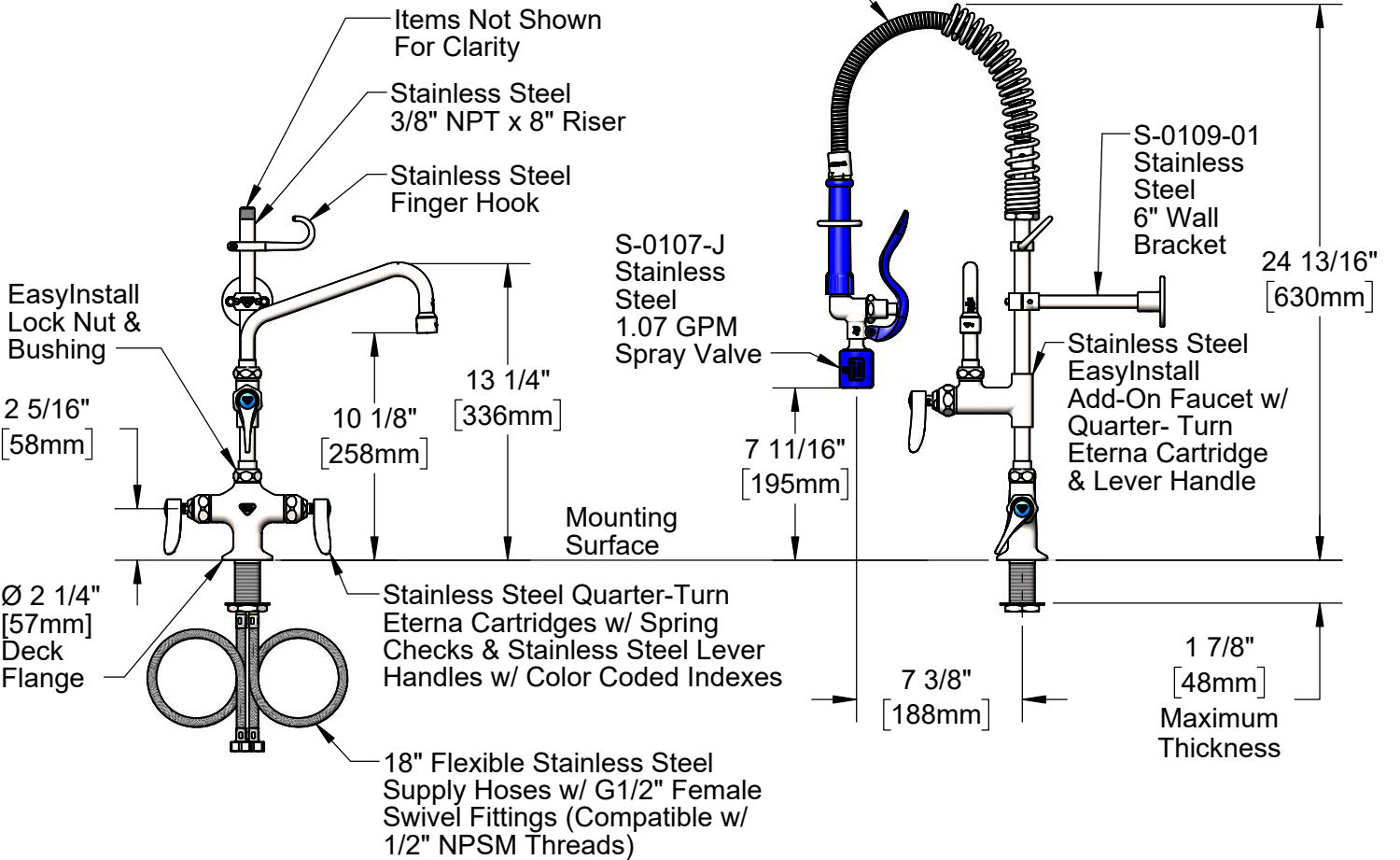

Rough-In Requirement:
 Ø 1 1/2" [38mm] Mounting Hole

Product Specifications:
 Pre-Rinse Unit: EasyInstall Stainless Steel Single Hole Deck Mount Mixing Faucet, SS Quarter-Turn Eterna Cartridges w/ Spring Checks, SS Lever Handles, SS Add-On Faucet, SS 8" Swing Nozzle, 24" Flexible Stainless Steel Hose, SS 1.07 GPM Spray Valve, SS 6" Wall Bracket & Flexible Stainless Steel Supply Hoses

Product Compliance:
 ASME A112.18.1 / CSA B125.1
 NSF 61 - Section 9
 NSF 372 (Low Lead Content)
 2019 DOE PRSV - Class II
 For Commercial Use Only



T&S BRASS AND BRONZE WORKS, INC.

2 Saddleback Cove / P.O. Box 1088
Travelers Rest, SC 29690

Model No.

SMPM-2DLN-08

Item No.

Travelers Rest, SC: 800-476-4103 • Simi Valley, CA: 800-423-0150 • Fax: 864-834-3518 • www.tsbrass.com

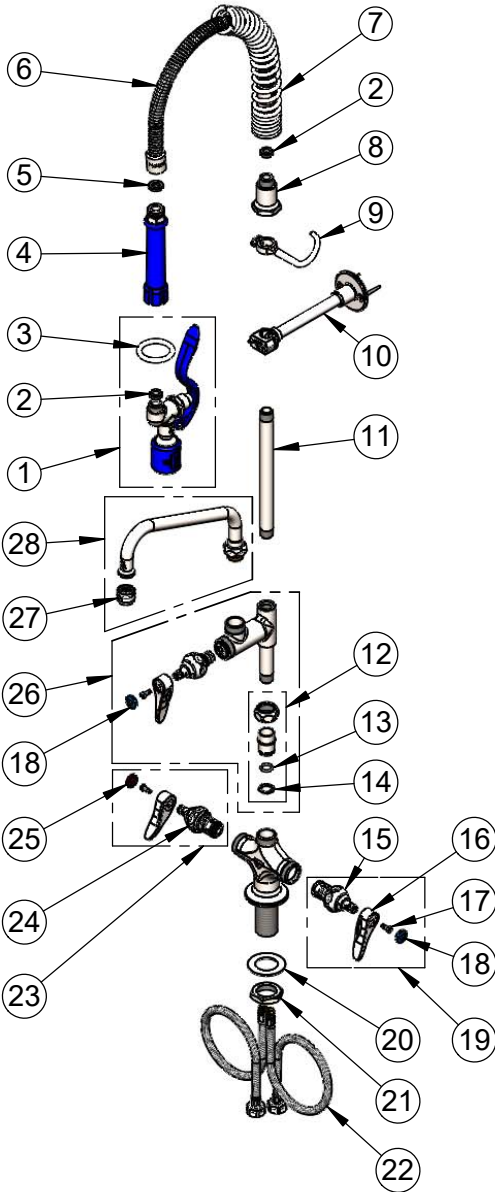

ITEM NO.	SALES NO.	DESCRIPTION
1	S-0107-J	Stainless Steel 1.07 GPM Spray Valve (Blue)
2	010476-45	#27 Washer
3	S000907-30	SS Spray Valve Hold Down Ring
4	S011482-30	Stainless Steel Grip Handle (Blue)
5	001014-45	Washer, Hose Barrel
6	S-0024-H2A	24" Flexible Stainless Steel Hose, Less Handle
7	S016795-30	Stainless Steel Compact Spring
8	S000821-30	Stainless Steel Spring Body
9	S004R	Stainless Steel Finger Hook
10	S-0109-01	Stainless Steel 6" Wall Bracket
11	S078X	Stainless Steel 3/8" NPT x 8" Riser
12	SEZ-K	Stainless Steel EasyInstall Kit: Nut, Bushing, O-Ring & Lock Washer
13	001065-45	O-Ring
14	014200-45	Star Washer, Anti-Rotation
15	S012442-30NS	Stainless Steel Quarter-Turn Eterna Cartridge w/ Spring Check, LTC
16	S001638-30NS	Lever Handle (New Style)
17	000925-45	Lab Handle Screw
18	018506-19NS	Blue Button Index, Press-in
19	S002711-30NS	Stainless Steel Quarter-Turn Eterna Cartridge w/ Spring Check, Handle, Blue Index & Screw, LTC
20	S007365-20	Stainless Steel Lock Washer
21	S000965-20	Stainless Steel Lock Nut
22	012436-45DR	Flexible Connector Hose
23	S002712-30NS	Stainless Steel Quarter-Turn Eterna Cartridge w/ Spring Check, Handle, Red Index & Screw, RTC
24	S012443-30NS	Stainless Steel Quarter-Turn Eterna Cartridge w/ Spring Check, RTC
25	001193-19NS	Red Button Index, Press-in
26	S-0155-LNEZ	Stainless Steel EasyInstall Add-On Faucet w/ Quarter-Turn Eterna Cartridge & Lever Handle, Less Nozzle
27	S-PT	SS Full Flow Stream Regulator, 55/64-27
28	S060X	Stainless Steel 8" Swing Nozzle

Product Specifications:

Pre-Rinse Unit: EasyInstall Stainless Steel Single Hole Deck Mount Mixing Faucet, SS Quarter-Turn Eterna Cartridges w/ Spring Checks, SS Lever Handles, SS Add-On Faucet, SS 8" Swing Nozzle, 24" Flexible Stainless Steel Hose, SS 1.07 GPM Spray Valve, SS 6" Wall Bracket & Flexible Stainless Steel Supply Hoses

Product Compliance:

ASME A112.18.1 / CSA B125.1
NSF 61 - Section 9
NSF 372 (Low Lead Content)
2019 DOE PRSV - Class II
For Commercial Use Only