

Architect/Engineering Specifications:

8" deck mount mixing faucet with polished chrome plated brass body, 5 7/8" swivel gooseneck with 1.5 GPM aerator, ceramic cartridges, 4" wrist action handles and 1/2" NPT male inlets. Certified to ASME A112.18.1/CSA B125.1, NSF 61-Section 9 and NSF 372. Meets ADA ANSI/ICC A117.1 requirements.

Job Name _____
 Model Specified _____ Quantity _____
 Variations Specified _____
 Date _____

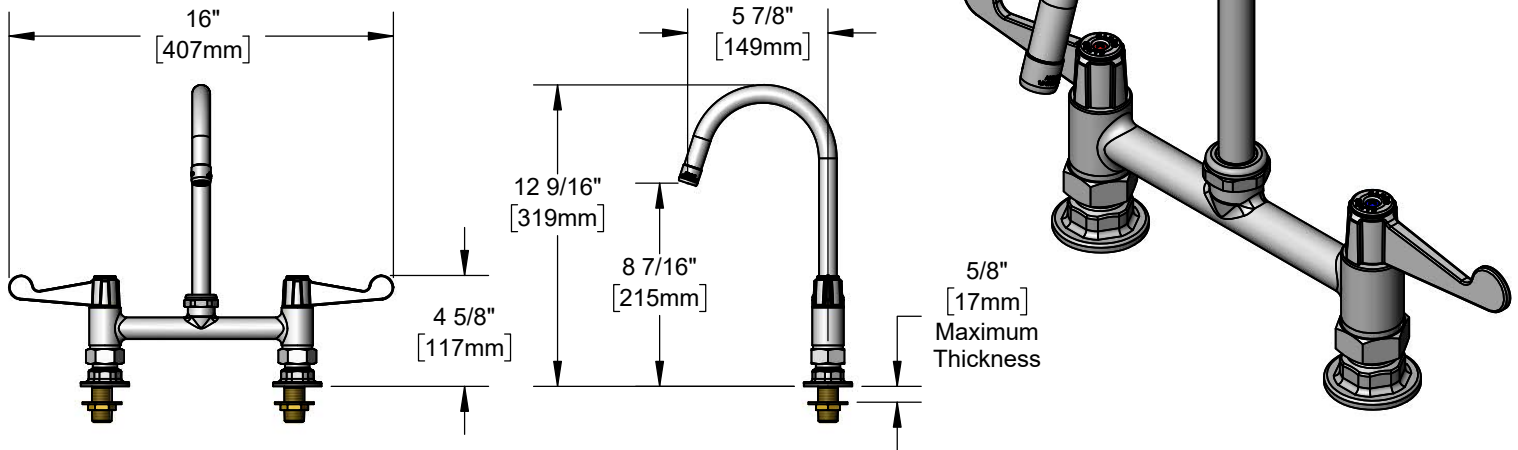

Features & Benefits:

- 8" deck mount mixing faucet with polished chrome plated brass body
- 5 7/8" equip swivel gooseneck w/ 1.5 GPM aerator
- equip quarter-turn ceramic cartridges
- equip 4" wrist action handles w/ color coded screws
- 1/2" NPT female inlets w/ Ø 2" flanges
- Adjustable centers from 7 3/4" to 8 1/4"
- 1/2" NPT male supply inlets
- Material: Polished chrome plated brass body & tubular spout and chrome plated metal handles

Product Compliance:

- ASME A112.18.1 / CSA B125.1
- NSF 61 - Section 9
- NSF 372 (Low Lead Content)
- ANSI A117.1 (ADA)

Warranty: One Year (Limited)

Performance Data:

- Pressure: 20 - 125 psi [1.38 - 8.62 bar]
- Temperature: 40 °F - 140 °F [4.44 °C - 60 °C]
- Flow Rate: 1.5 GPM [5.68 L/min] @ 60 psi [4.14 bar]



ADA Compliant