

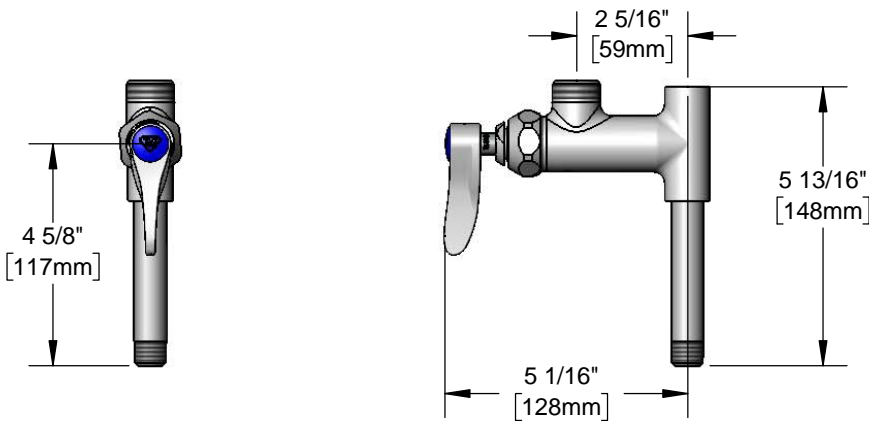

**Architect/Engineering Specifications:**

Add-on faucet with polished chrome plated brass body (less nozzle), 3/8" NPT female outlet, compression cartridge with spring check, lever handle and 3/8" NPT male inlet. Certified to ASME A112.18.1/CSA B125.1, NSF 61-Section 9 and NSF 372. Meets ADA ANSI/ICC A117.1 requirements.

Job Name \_\_\_\_\_  
 Model Specified \_\_\_\_\_ Quantity \_\_\_\_\_  
 Variations Specified \_\_\_\_\_  
 Date \_\_\_\_\_

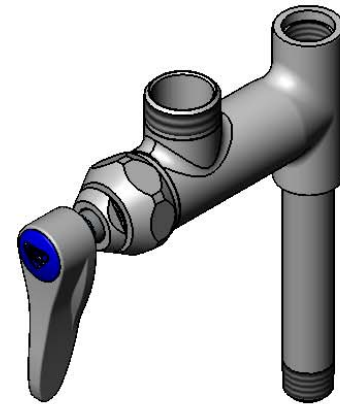

**Features & Benefits:**

- Add-On faucet w/ polished chrome plated brass body (less nozzle)
- 3/8" NPT female outlet
- Swivel outlet accepts T&S swing nozzles
- Quarter-turn Eterna compression cartridge w/ spring check
- Lever handle
- 4" Nipple w/ 3/8" NPT male inlet
- Material: Polished chrome plated brass body, nipple and chrome plated metal handle

**Product Compliance:**

- ASME A112.18.1 / CSA B125.1
- NSF 61 - Section 9
- NSF 372 (Low Lead Content)
- ANSI A117.1 (ADA)



**Warranty:** One Year (Limited)

**Performance Data:**

- Pressure: 20 - 125 psi
- Temperature: 40°F - 140°F
- Flow Rate: 9.73 GPM @ 60 psi  
(Outlet Device &/or Final Configuration May Reduce Flow Rate)



**T&S Swing Nozzles**

- 059X 6" Swing Nozzle
- 060X 8" Swing Nozzle
- 061X 10" Swing Nozzle
- 062X 12" Swing Nozzle
- 063X 14" Swing Nozzle
- 064X 16" Swing Nozzle
- 065X 18" Swing Nozzle
- 066X 12" Double Joint Swing Nozzle
- 067X 15" Double Joint Swing Nozzle
- 068X 18" Double Joint Swing Nozzle
- 069X 24" Double Joint Swing Nozzle

**Optional Add-On Faucet Outlets (Series 1 / VR Series 6)**

GPM	Aerated	VR Aerated
1.0	<input type="checkbox"/> B-0199-01-F10	<input type="checkbox"/> B-0199-06-F10
1.5	<input type="checkbox"/> B-0199-01-WS	<input type="checkbox"/> B-0199-06-WS
2.2	<input type="checkbox"/> B-0199-01	<input type="checkbox"/> B-0199-06

**T&S Swivel Goosenecks (D x K)**

- 131X 2 13/16" x 2 9/16" Swivel Gooseneck
- 132X 2 5/8" x 5 7/16" Swivel Gooseneck
- 133X 5 11/16" x 6 1/4" Swivel Gooseneck
- 135X 8 3/4" x 5 5/8" Swivel Gooseneck

**Optional Handles**

- 4" Wrist Action
- Lever (Standard)
- 4-Arm

**Optional Cartridges With Checks**

- Quarter-Turn Cerama w/ Check Valve
- Quarter-Turn Eterna w/ Spring Check (Standard)

