



T&S BRASS AND BRONZE WORKS, INC.

2 Saddleback Cove / P.O. Box 1088
Travelers Rest, SC 29690

Model No.

B-2349-01

Item No.

Travelers Rest, SC: 800-476-4103 • Simi Valley, CA: 800-423-0150 • Fax: 864-834-3518 • www.tsbrass.com



ADA Compliant

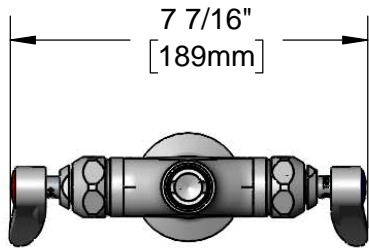

This Space for Architect/Engineer Approval

Job Name _____ Date _____

Model Specified _____ Quantity _____

Customer/Wholesaler _____

Contractor _____

Architect/Engineer _____

EZ-K
EasyInstall Kit
Converts Rigid Risers &
Nozzles For Use with
Swivel Outlet (Included)

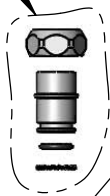

Swivel Outlet Accepts
Standard T&S Swing Nozzles
and EasyInstall Risers.

Quarter-Turn Eterna
Cartridges w/ Spring
Checks & Lever Handles
w/ Color Coded Indexes

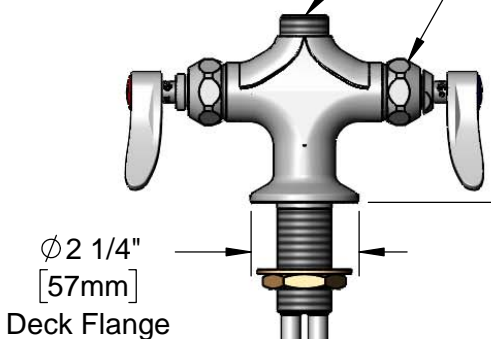
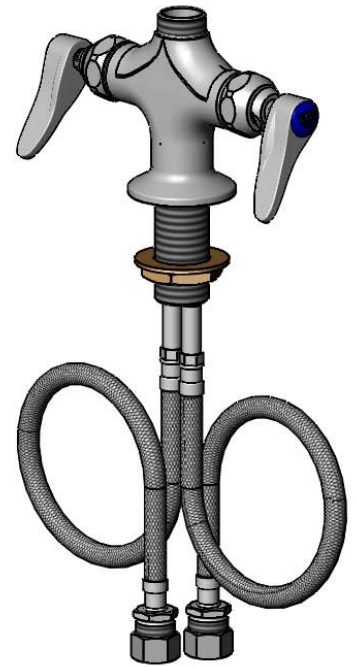

Mounting
Surface

Ø 2 1/4"
[57mm]
Deck Flange

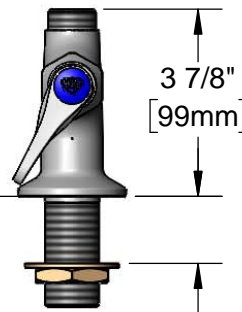

3 7/8"
[99mm]

Ø 1 1/8"
[29mm]

1 3/8"
[35mm]
Maximum
Thickness

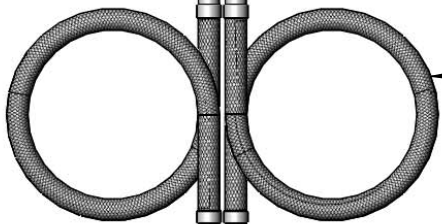

18" Flexible
Stainless Steel
Supply Hoses

Compression Fittings
for 5/8" O.D. Copper Tubing
(Remove Compression Nut
for 1/2" NPSM Male)

Rough-In Requirement:
Ø 1 1/2" [38mm] Mounting Hole

Product Specifications:

Single Hole Deck Mount Mixing Faucet, Quarter-Turn Eterna Cartridges w/ Spring Checks, Lever Handles & 18" Flexible Stainless Steel Supply Hoses w/ 1/2" NPSM Inlets, Less Nozzle

Product Compliance:

ASME A112.18.1 / CSA B125.1
NSF 61 - Section 9
NSF 372 (Low Lead Content)
ANSI A117.1 (ADA)



T&S BRASS AND BRONZE WORKS, INC.

2 Saddleback Cove / P.O. Box 1088
Travelers Rest, SC 29690

Model No.

B-2349-01

Item No.

Travelers Rest, SC: 800-476-4103 • Simi Valley, CA: 800-423-0150 • Fax: 864-834-3518 • www.tsbrass.com

ITEM NO.	SALES NO.	DESCRIPTION
1	001193-19NS	Red Button Index, Press-in
2	000925-45	Lab Handle Screw
3	002712-40NS	Quarter-Turn Eterna Cartridge w/ Spring Check, Handle, Red Index & Screw, RTC
4	012443-40NS	Quarter-Turn Eterna Cartridge w/ Spring Check, RTC
5	012442-40NS	Quarter-Turn Eterna Cartridge w/ Spring Check, LTC
6	002711-40NS	Quarter-Turn Eterna Cartridge w/ Spring Check, Handle, Blue Index & Screw, LTC
7	001638-45NS	Lever Handle (New Style)
8	018506-19NS	Blue Button Index, Press-in
9	002290-45	Lock Washer
10	000965-45	Lock Nut
11	012534-45	18" Flexible Supply Hose (2)

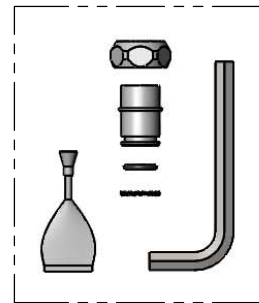
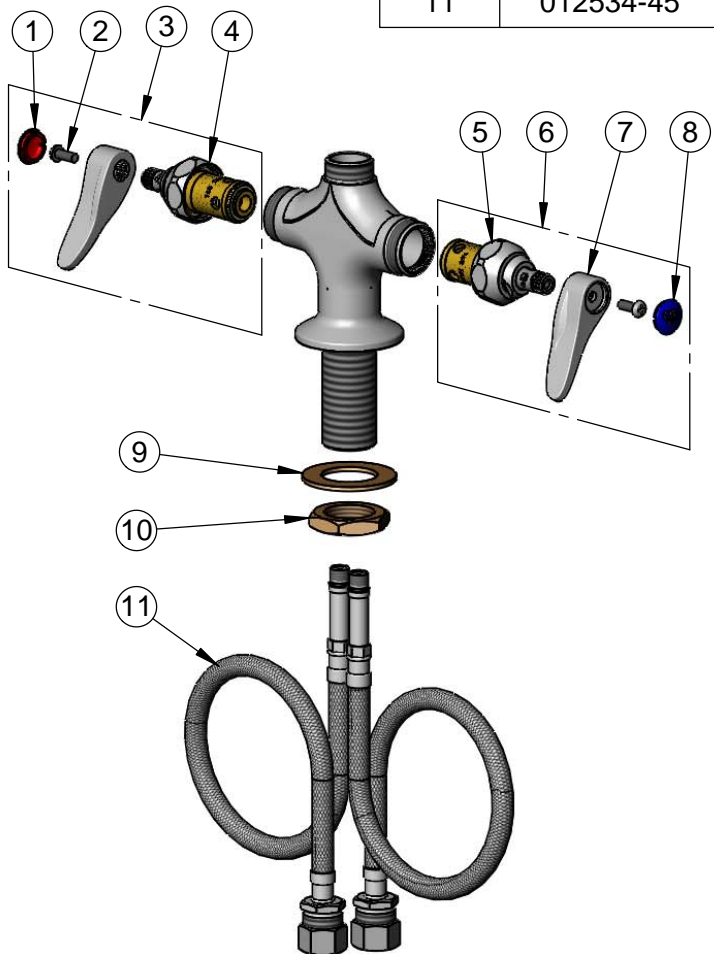

EZ-K
Converts Rigid Outlets to
EasyInstall for Use with
T&S Swivel Base Faucets

Product Specifications:

Single Hole Deck Mount Mixing Faucet, Quarter-Turn Eterna Cartridges w/ Spring Checks, Lever Handles & 18" Flexible Stainless Steel Supply Hoses w/ 1/2" NPSM Inlets, Less Nozzle

Product Compliance:

ASME A112.18.1 / CSA B125.1
NSF 61 - Section 9
NSF 372 (Low Lead Content)
ANSI A117.1 (ADA)