

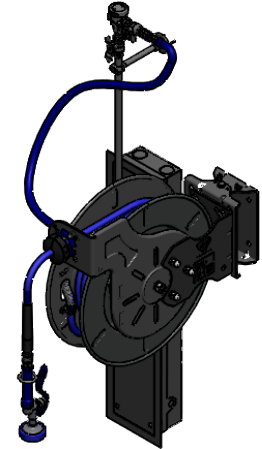

Architect/Engineering Specifications:

Recess mounted stainless steel hose reel cabinet containing 1/2" union inlets, 1/2" check valves, loose key stops, mixing valve with ceramic cartridges and 4-arm handles, shut-off control valve with ceramic cartridge and 4-arm handle, hose reel connector kit with 1/2" NPT elbow, 18" riser and vacuum breaker, open stainless steel reel with 3/8" x 50' heavy-duty non-marking hose, ratcheting system, high flow spray valve with swivel, multi-fit bracket, stainless steel wall mount swing bracket and adjustable hose bumper. Certified to ASSE 1056.

Job Name _____
 Model Specified _____ Quantity _____
 Variations Specified _____
 Date _____

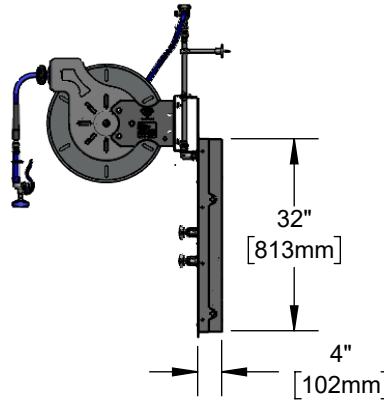
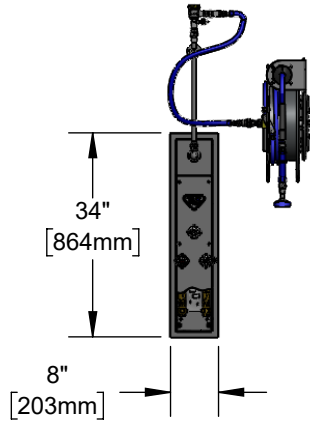

Features & Benefits:

- Recess mount stainless steel control cabinet with removeable wall flange
- 1/2" NPT female union inlets
- 1/2" in-line check valves
- Loose key supply stops with tee handles and screws
- Mixing valve with quarter-turn Cerama cartridges w/ check valves
- Control valve with quarter-turn Cerama cartridge w/ check valve
- 4-arm handles w/ color-coded indexes
- 1/2" NPT inlet swivel elbow and flange
- EasyInstall 18" riser
- 6" wall bracket
- Continuous vacuum breaker
- 36" flexible water hose connector with stainless steel quick disconnect
- Open stainless steel reel with 3/8" NPT female inlet
- High flow blue spray valve with swivel
- 3/8" x 50' heavy-duty non-marking hose rated to 300 PSI
- Multi-fit bracket for wall, ceiling or under counter mounting
- EasyInstall universal stainless steel wall mount hose reel 100° swing bracket
- Material: Stainless steel cabinet, open reel & wall bracket, chrome plated brass elbow & riser, brass control unit components and chrome plated metal handle

Product Compliance:

- NSF 61 Exempt (Non-Potable)
- ASSE 1056 (VB)
- 2019 DOE PRSV Non-Compliant



Warranty: One Year (Limited)

- Hose Reel: Two Years (Limited)

Performance Data:

- Pressure: 20 - 125 psi [1.38 - 8.62 bar]
- Temperature: 40°F - 140°F [4.44°C - 60°C]
- Flow Rate: 3.20 GPM [12.11 L/min] @ 60 psi [4.14 bar]

Optional Hose Reel Spray Valves

- B-0107 Spray Valve
- B-0108 Ergonomic Medium Flow Spray Valve
- B-0108-H Ergonomic High Flow Spray Valve
- EB-0107 High Flow Spray Valve (Standard)
- EB-2322 Extended Spray Wand
- MV-2516-24 Stainless Steel Rear Trigger Water Gun
- MV-2522-24 Stainless Steel Front Trigger Water Gun
- MV-3516-24 Aluminum Rear Trigger Water Gun

