



Architect/Engineering Specifications:

8" wall mount mixing faucet with polished chrome plated brass body, 18" riser, 44" flexible stainless steel hose, 0.65 GPM low flow spray valve with insulated grip handle, ceramic cartridges with check valves, lever handles, 1/2" NPT female inlets, spray valve holder, overhead spring, and 18" adjustable wall bracket. Certified to ASME A112.18.1/CSA B125.1, NSF 61-Section 9 and NSF 372. 2019 DOE PRSV - Class I compliant.

Job Name _____

Model Specified _____ Quantity _____

Variations Specified _____

Date _____

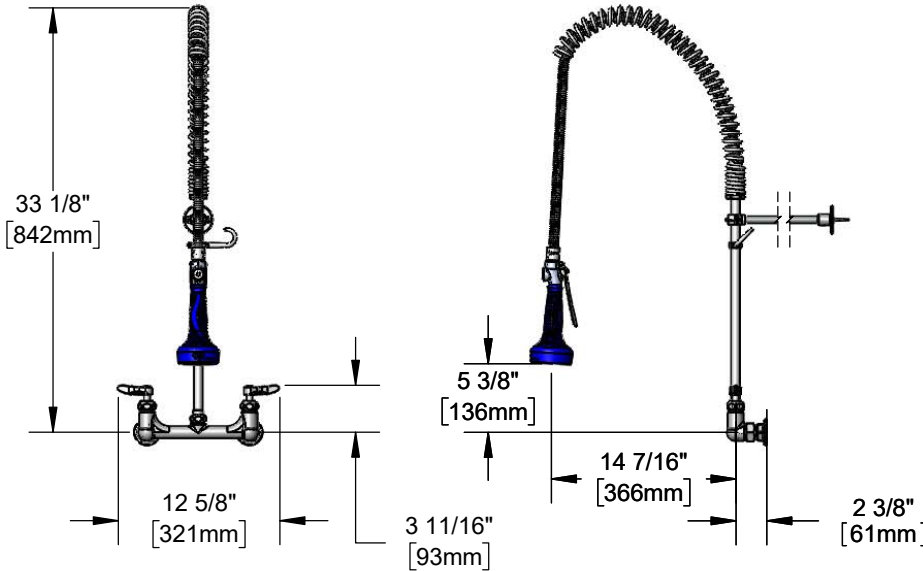

Features & Benefits:

- 8" wall mount mixing faucet w/ polished chrome plated brass body
- EasyInstall 18" riser for quick installation
- 44" flexible stainless steel hose
- 0.65 GPM low flow JeTSpray valve with insulated grip handle, stainless steel trigger and trigger lock
- Quarter-turn Cerama cartridges with check valves to prevent water cross flow
- Lever handles w/ color coded indexes
- 1/2" NPT female eccentric inlets with Ø 2" flanges
- Adjustable centers from 7 3/4" to 8 1/4"
- 18" wall bracket
- Material: Polished chrome plated brass body, riser & spray valve body, stainless steel hose, and chrome plated metal handles

Product Compliance:

- ASME A112.18.1 / CSA B125.1
- NSF 61 - Section 9
- NSF 372 (Low Lead Content)
- 2019 DOE PRSV - Class I



Warranty: Three Year (Limited)

- Cerama Cartridge: Lifetime (Limited)

Performance Data:

- Pressure: 20 - 125 psi
- Temperature: 40 °F - 140 °F
- Flow Rate: 0.65 GPM @ 60 psi

Optional Handles

- 4" Wrist Action
- Lever (Standard)
- 4-Arm

Optional Cartridges With Checks

- Quarter-Turn Cerama w/ Check Valve (Standard)
- Quarter-Turn Eterna w/ Spring Check

Optional Pre-Rinse Spray Valves

- B-0107 (1.15 GPM)
- B-0107-C (0.65 GPM)
- B-0107-J (1.07 GPM)
- B-0108 (1.07 GPM)
- B-0108-C (0.65 GPM) (Standard)

