



T&S BRASS AND BRONZE WORKS, INC.
 2 Saddleback Cove / P.O. Box 1088
 Travelers Rest, SC 29690

Model No.
B-0199-06-N035

Item No.

Travelers Rest, SC: 800-476-4103 • Simi Valley, CA: 800-423-0150 • Fax: 864-834-3518 • www.tsbrass.com

This Space for Architect/Engineer Approval

Job Name _____ Date _____

Model Specified _____ Quantity _____

Customer/Wholesaler _____

Contractor _____

Architect/Engineer _____

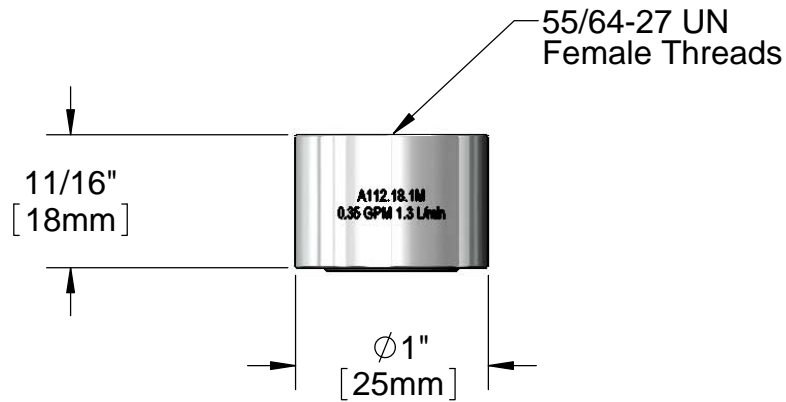

Furnished with Vandal Resistant Key

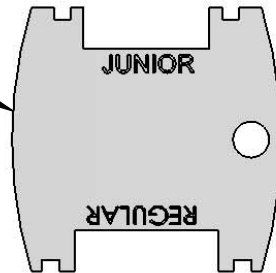

Product Specifications:
 Vandal Resistant 0.35 GPM Non-Aerated Spray Device,
 55/64-27 UN Female w/ Installation Key

Drawn DMH	Checked KJG	Approved JHB
Scale: 1:1		Date: 01/28/14