



Epoxy Coated Retractable Hose Reels

TAG:

5HR-222-12

Open Epoxy Coated Steel Hose Reel

Architect/Engineering Specifications:

Open epoxy coated steel hose reel with front trigger brass water gun, 3/8" x 25' hose, ratcheting system, multi-fit bracket, adjustable hose bumper and 3/8" NPT female inlet.

Job Name _____
Model Specified _____ Quantity _____
Variations Specified _____
Date _____

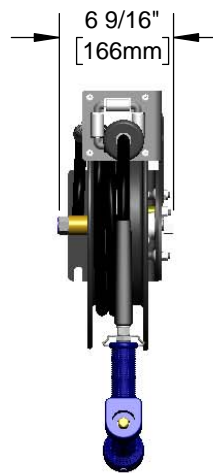
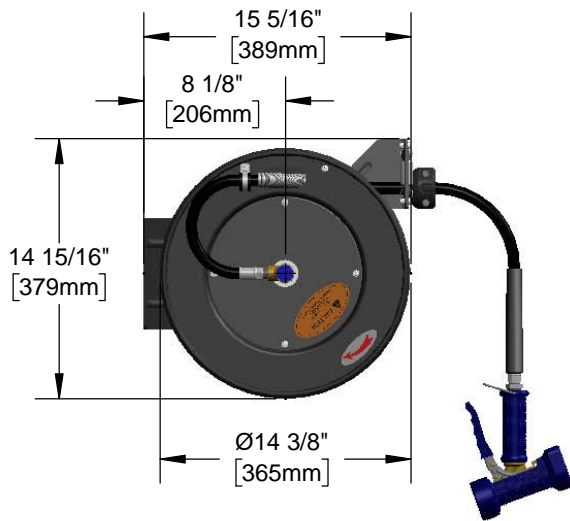

Features & Benefits:

- Open coated hose reel
- Front trigger brass water gun
- 3/8" x 25' hose
- Ratcheting system holds the length of hose until a slight tug to retract automatically
- 3/8" NPT female inlet
- Adjustable hose bumper
- Multi-fit bracket for wall, ceiling or under counter mounting
- Material: Epoxy coated steel open reel and wall bracket, polished chrome plated spray valve

Product Compliance:

- NSF 61 Exempt (Non-Potable)
- EPAAct 2005 Non-Compliant (PRSV)

Warranty: One Year (Limited)

- Hose: One Year (Limited)

Performance Data:

- Pressure: 20 - 125 psi
- Temperature: 40 °F - 140 °F
- Flow Rate: 4.20 GPM @ 60 psi



equip Foodservice Accessories



• 2 Saddleback Cove • Travelers Rest, SC 29690
Ph 800-891-4808 • Fax 800-868-0084
www.tsbrass.com

Date: 04/06/17