



Gas Hoses
HG-2D-60S

TAG:

SAFET-LINK Gas Hose

Architect/Engineering Specifications:

60" coated gas appliance connector hose with 3/4" NPT male swivel connections. Certified to ANSI Z21.69/CSA 6.16 and NSF 2.

Job Name _____
 Model Specified _____ Quantity _____
 Variations Specified _____
 Date _____

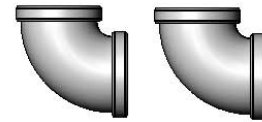
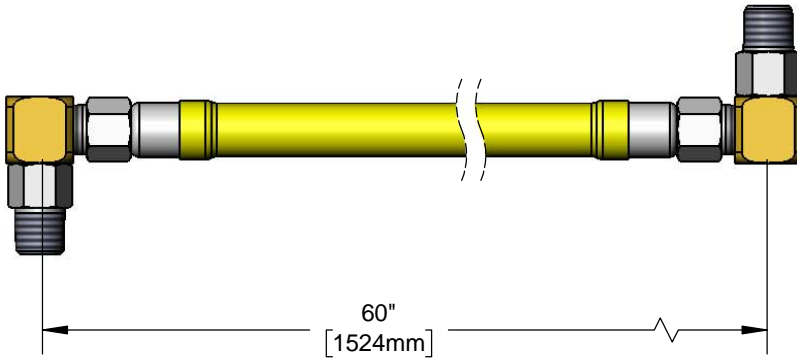
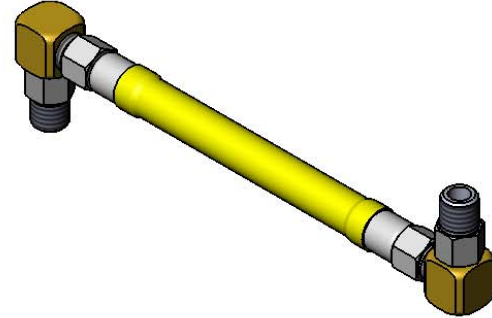

90° Elbows

Features & Benefits:

- 60" coated gas appliance connector
- 3/4" NPT male swivel inlet
- 3/4" NPT male swivel outlet
- (2) 90° elbows included
- 360° rotatable hex nut rotates completely and freely
- Optimum torsional relief improves safety, increases connector life
- Provides efficient, full gas flow
- Material: Extruded coated stainless steel braids

Product Compliance:

- ANSI Z21.69 / CSA 6.16
- NSF 2
- NFPA 54

Warranty: Five Year (Limited)

Performance Data:

- Gas Pressure: 1/2 psi max
- Temperature: 350° F max
- Capacity: 200,000 BTU/ hr min



T&S BRASS AND BRONZE WORKS, INC.



• 2 Saddleback Cove • Travelers Rest, SC 29690
 Ph 800-476-4103 • Fax 864-834-3518
 • Simi Valley, CA • Ph 800-423-0150 • www.tsbrass.com

Date: 06/23/17