



Pre-Rinse Units

MPZ-2DCN-06

TAG:

Easy Install

Mini Pre-Rinse Unit

Architect/Engineering Specifications:

Single hole deck mount mixing faucet with polished chrome plated brass body, add-on faucet with compression cartridge and club handle, 6" swing nozzle with stream regulator outlet, 8" riser, 24" flexible stainless steel hose with heat resistant handle, 1.15 GPM spray valve, compression cartridges with spring checks, club handles, 18" flexible stainless steel supply hoses with 1/2" NPSM / 5/8" compression connections, 6" adjustable wall bracket, spray valve holder and overhead spring. Certified to ASME A112.18.1/CSA B125.1, NSF 61-Section 9 and NSF 372. 2019 DOE PRSV - Class II compliant.

Job Name _____
 Model Specified _____ Quantity _____
 Variations Specified _____
 Date _____

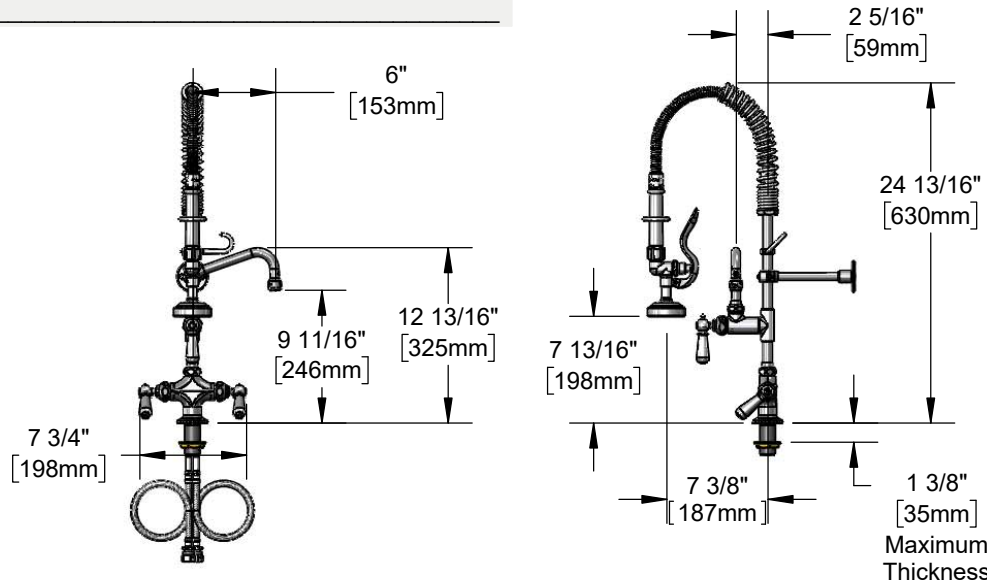

Features & Benefits:

- Single hole deck mount mixing faucet w/ polished chrome plated brass body & ϕ 2 1/4" Deck Flange
- EasyInstall add-on faucet w/ polished chrome plated brass body
- 6" swing nozzle w/ stream regulator outlet, Series 1
- 8" rigid riser
- 24" flexible stainless steel hose w/ heat resistant gray handle and hold down ring
- 1.15 GPM spray valve
- Quarter-turn Eterna compression cartridges with spring checks to prevent cross flow of water
- Decorative club handles w/ chrome plated indexes
- 18" flexible stainless steel supply hoses w/ 1/2" NPSM / 5/8" compression connections
- 6" adjustable wall bracket
- Material: Polished chrome plated brass body & tubular nozzle, add-on faucet body, riser & spray valve, stainless steel hose and chrome plated metal handles

Product Compliance:

- ASME A112.18.1 / CSA B125.1
- NSF 61 - Section 9
- NSF 372 (Low Lead Content)
- 2019 DOE PRSV - Class II
- For Commercial Use Only



Warranty: Three Year (Limited)

Performance Data:

- Pressure: 20 - 125 psi
- Temperature: 40 °F - 140 °F
- Flow Rate:
 - Spray Valve: 1.15 GPM @ 60 psi
 - Add-On Faucet: 5.57 GPM @ 60 psi

Optional Cartridges With Checks

- Quarter-Turn Cerama w/ Check Valve
- Quarter-Turn Eterna w/ Spring Check (Standard)

Optional Handles

- 4" Wrist Action
- Lever
- 4-Arm

Optional Pre-Rinse Spray Valves

- B-0107 (1.15 GPM) (Standard)
- B-0107-C (0.65 GPM)
- B-0107-J (1.07 GPM)
- B-0108 (1.07 GPM)
- B-0108-C (0.65 GPM)

Optional Add-On Faucet Outlets (Series 1 / VR Series 6)

GPM	Aerated	VR Aerated (VR Laminar)
1.0	<input type="checkbox"/> B-0199-01-F10	<input type="checkbox"/> B-0199-06-F10
1.5	<input type="checkbox"/> B-0199-01-WS	<input type="checkbox"/> B-0199-06-WS
2.2	<input type="checkbox"/> B-0199-01	<input type="checkbox"/> B-0199-06



T&S BRASS AND BRONZE WORKS, INC.



• 2 Saddleback Cove • Travelers Rest, SC 29690
 Ph 800-476-4103 • Fax 864-834-3518
 • Simi Valley, CA • Ph 800-423-0150 • www.tsbrass.com

Date: 03/21/19