



Service Sink / Mop Sink Faucets

B-0665-CR-POL

TAG:

Service Sink Faucet

Architect/Engineering Specifications:

8" wall mount mixing faucet with polished chrome plated brass body, polished chrome plated brass spout with vacuum breaker, pail hook and garden hose male outlet, ceramic cartridges with check valves, lever handles, 1/2" NPT female inlets and upper support rod. Certified to ASME A112.18.1/CSA B125.1 NSF 61-Section 9, NSF 372 and ASSE 1001. Meets ADA ANSI/ICC A117.1 requirements.

Job Name _____
 Model Specified _____ Quantity _____
 Variations Specified _____
 Date _____

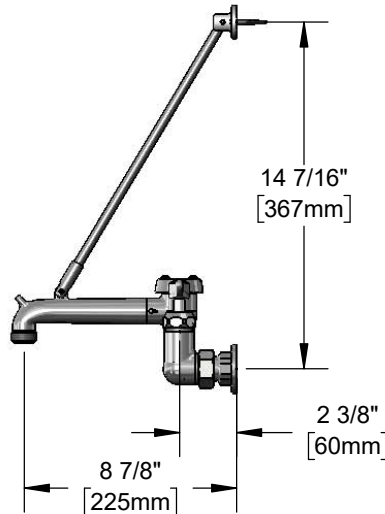
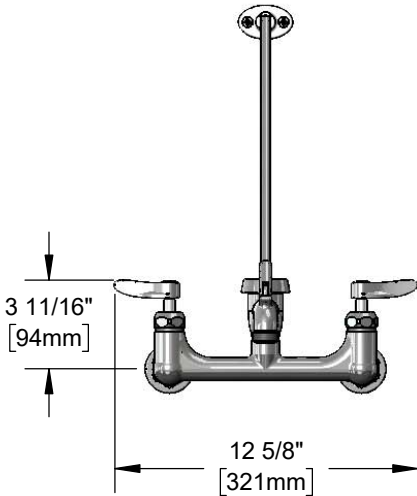

Features & Benefits:

- 8" wall mount mixing faucet with polished chrome plated brass body
- Vacuum breaker spout with pail hook & garden hose male outlet
- Quarter-turn Cerama cartridges with check valves to prevent cross flow of water
- Lever handles with color coded indexes
- 1/2" NPT female eccentric inlets with Ø 2" flanges
- Adjustable centers from 7 3/4" to 8 1/4"
- Top support wall brace
- Material: Polished chrome plated brass body & spout and chrome plated metal handles

Product Compliance:

- ASME A112.18.1 / CSA B125.1
- NSF 61 - Section 9
- NSF 372 (Low Lead Content)
- ANSI A117.1 (ADA)
- ASSE 1001 (VB)

Warranty: One Year (Limited)

- Cerama Cartridge: Lifetime (Limited)

Performance Data:

- Pressure: 20 - 125 psi
- Temperature: 40 °F - 180 °F
- Flow Rate: 9.71 GPM @ 60 psi



ADA Compliant



Optional Handles

- 4" Wrist Action
- Lever (Standard)
- 4-Arm

Optional Cartridges With Checks

- Quarter-Turn Cerama w/ Check Valve (Standard)
- Quarter-Turn Eterna w/ Spring Check



T&S BRASS AND BRONZE WORKS, INC.



• 2 Saddleback Cove • Travelers Rest, SC 29690
 Ph 800-476-4103 • Fax 864-834-3518
 • Simi Valley, CA • Ph 800-423-0150 • www.tsbrass.com

Date: 11/02/18