

ADA Compliant

This Space for Architect/Engineer Approval

Job Name _____ Date _____

Model Specified _____ Quantity _____

Customer/Wholesaler _____

Contractor _____

Architect/Engineer _____

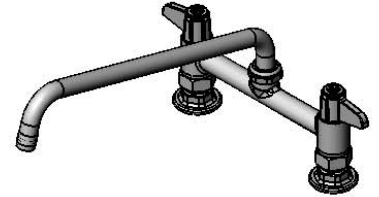

5SP-14
14" equip Swing Nozzle
w/ Laminar Flow Device.
Rigid Conversion Requires
014200-45 Lock Washer
(Sold Separately)

Ceramic Cartridges &
equip Lever Handles
w/ Color Coded Screws

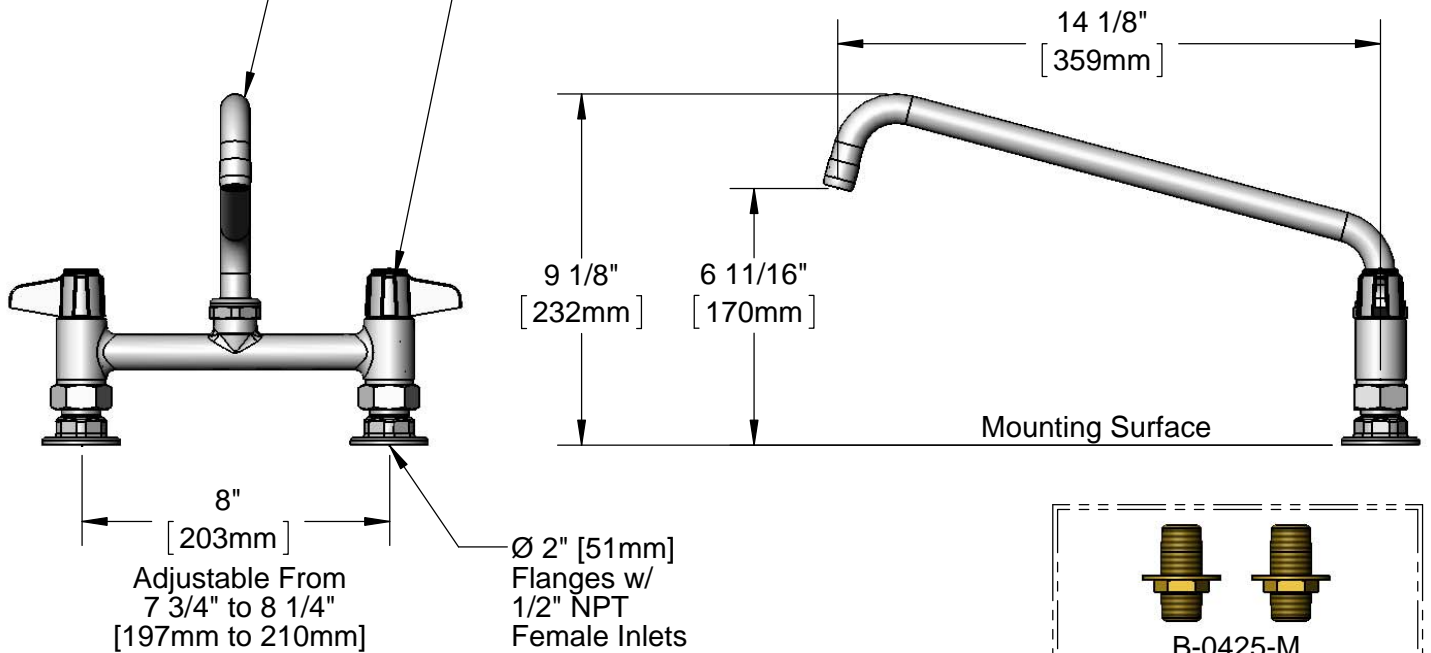

Adjustable From
7 3/4" to 8 1/4"
[197mm to 210mm]

Ø 2" [51mm]
Flanges w/
1/2" NPT
Female Inlets



Rough-In Requirement:
(2) Ø 1" [25mm] Mounting Holes

Model Number 5F-8DLS14	Date 12/09/13	Scale 1:4	Drawn DHL	Checked DMH	Approved JHB
----------------------------------	-------------------------	---------------------	---------------------	-----------------------	------------------------



Product Specifications:

**8" Deck Mount Mixing Faucet w/ Ceramic Cartridges,
equip Lever Handles, 14" equip Swing Nozzle
& 1/2" NPT Supply Nipple Kit**

equip Foodservice Accessories
2 Saddleback Cove, P.O. Box 1088
Travelers Rest, South Carolina 29690
Phone: 800.891.4808 Fax: 800.868.0084

ITEM NO.	SALES NO.	DESCRIPTION
1	014250-45	Laminar Flow Device
2	5SP-14	14" equip Swing Nozzle
3	013839-25	equip Swivel Nut
4	013848-45	equip Swivel Piece O-ring
5	5-HDL-L	equip Lever Handle w/ Color Coded Screws
6	013788-45	equip Ceramic Cartridge, LTC
7	001019-45	Coupling Nut Washer
8	00AA	1/2" NPT Female Eccentric Flange
9	B-0425-M	1/2" NPT Supply Nipple Kit (2)
10	013787-45	equip Ceramic Cartridge, RTC

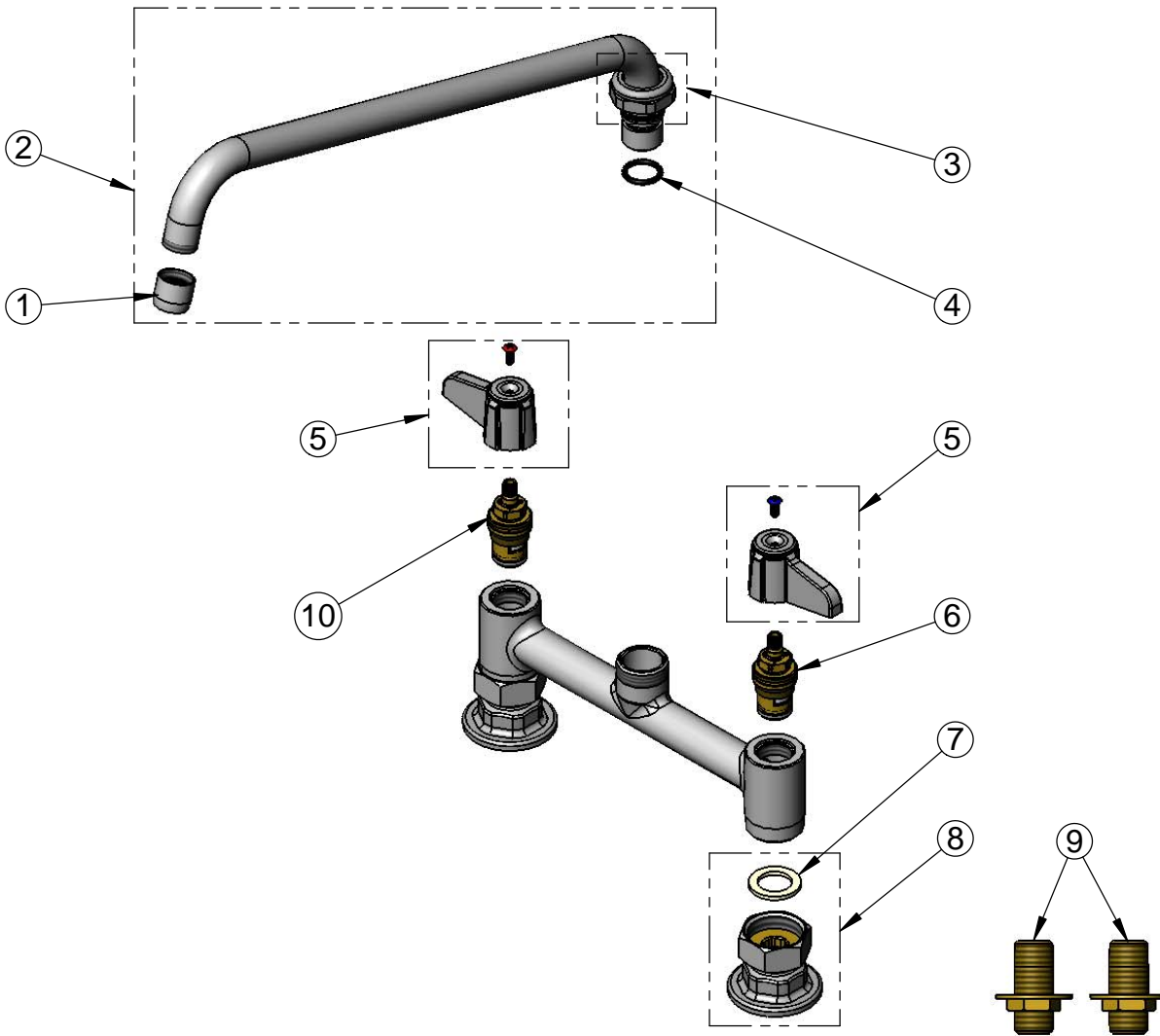

Model Number
5F-8DLS14

Date
12/09/13

Scale
NTS

Drawn
DHL

Checked
DMH

Approved
JHB



Product Specifications:

**8" Deck Mount Mixing Faucet w/ Ceramic Cartridges,
equip Lever Handles, 14" equip Swing Nozzle
& 1/2" NPT Supply Nipple Kit**

equip Foodservice Accessories
2 Saddleback Cove, P.O. Box 1088
Travelers Rest, South Carolina 29690
Phone: 800.891.4808 Fax: 800.868.0084