



**Big-Flo Faucets**  
**BF-0299-12**

TAG:

*Single Wall Mount Faucet*

**Architect/Engineering Specifications:**

Single wall mount large flow faucet with compression cartridge, 12" plain end swing nozzle, 4-arm handle and 3/4" NPT street elbow. Certified to ASME A112.18.1 / CSA B125.1, NSF 61-Section 9 and NSF 372. Meets ADA ANSI/ICC A117.1 requirements.

Job Name \_\_\_\_\_  
 Model Specified \_\_\_\_\_ Quantity \_\_\_\_\_  
 Variations Specified \_\_\_\_\_  
 Date \_\_\_\_\_

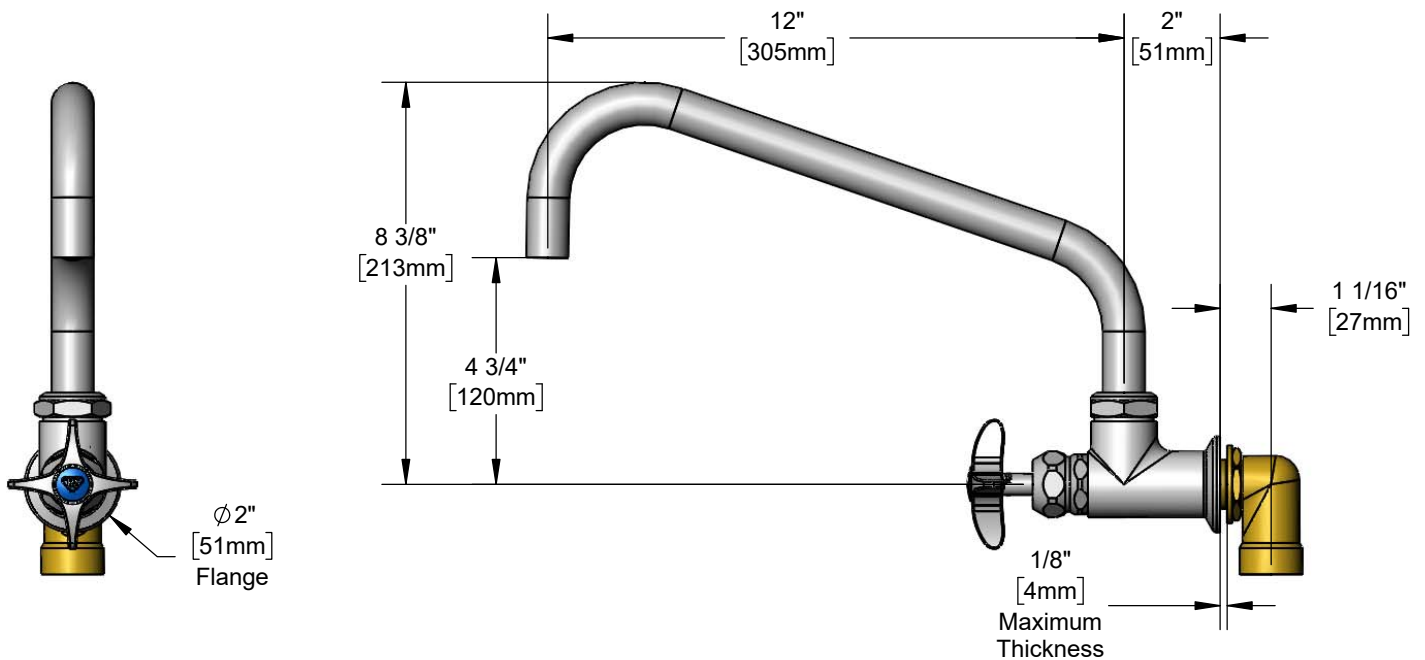
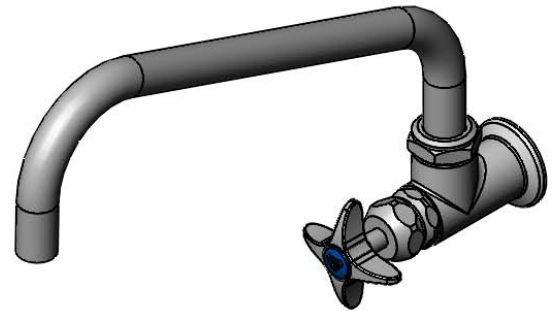

**Features & Benefits:**

- Single wall mount Big-Flo faucet
- Big-Flo cartridge
- 12" plain end swing nozzle
- Lock washer provided for rigid application
- 4-arm handle with color coded index
- 3/4" NPT street elbow
- Material: Chrome plated brass body and nozzle and chrome plated metal handle

**Product Compliance:**

- ASME A112.18.1 / CSA B125.1
- NSF 61 - Section 9
- NSF 372 (Low Lead Content)
- ANSI A117.1 (ADA)

**Warranty:** One Year (Limited)

**Performance Data:**

- Pressure: 20 - 125 psi [1.38 - 8.62 bar]
- Temperature: 40 °F - 140 °F [4.44 °C - 60 °C]
- Flow Rate: 33.13 GPM [125.41 L/min] @ 60 psi [4.14 bar]



**ADA Compliant**



**T&S BRASS AND BRONZE WORKS, INC.**



• 2 Saddleback Cove • Travelers Rest, SC 29690  
 Ph 800-476-4103 • Fax 864-834-3518  
 • Simi Valley, CA • Ph 800-423-0150 • www.tsbrass.com

Date: 08/31/20