



T&S BRASS AND BRONZE WORKS, INC.

2 Saddleback Cove / P.O. Box 1088
Travelers Rest, SC 29690

Model No.

B-0200

Item No.

Travelers Rest, SC: 800-476-4103 • Simi Valley, CA: 800-423-0150 • Fax: 864-834-3518 • www.tsbrass.com



ADA Compliant

This Space for Architect/Engineer Approval

Job Name _____ Date _____

Model Specified _____ Quantity _____

Customer/Wholesaler _____

Contractor _____

Architect/Engineer _____

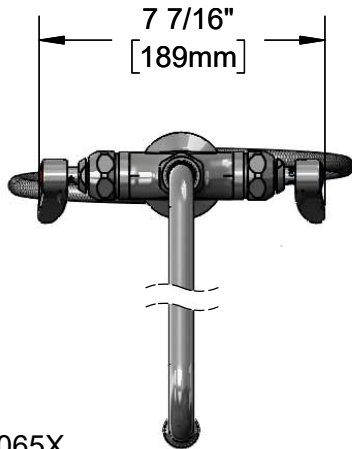

7 7/16"
[189mm]

065X
18" Swing Nozzle w/
Stream Regulator Outlet

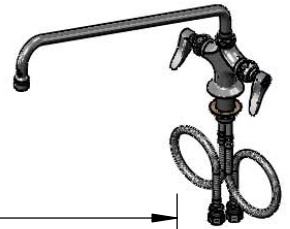

18"
[458mm]

Quarter-Turn
Eterna Cartridges
w/ Spring Checks
& Lever Handles
w/ Color Coded
Indexes

Swivel Joint
Converts to Rigid w/
014200-45
Lock Washer (Included).

2 5/16"
[58mm]

9 1/8"
[231mm]

12 1/4"
[311mm]

Mounting Surface

Ø 2 1/4" [57mm] Flange w/
Ø 1 1/8" [29mm] Shank

1 3/8"
[35mm]
Maximum
Thickness

18" Flexible
Stainless Steel
Supply Hoses

Compression Fittings
for 5/8" O.D. Copper Tubing
(Remove Compression Nut
for 1/2" NPSM Male)

Rough-In Requirement:
Ø 1 1/2" [38mm] Mounting Hole

Product Specifications:

Single Hole Deck Mount Mixing Faucet, Quarter-Turn Eterna Cartridges w/ Spring Checks, Lever Handles, 18" Swing Nozzle & 18" Flexible Stainless Steel Supply Hoses w/ 1/2" NPSM Male Inlets

Product Compliance:

ASME A112.18.1 / CSA B125.1
NSF 61 - Section 9
NSF 372 (Low Lead Content)
ANSI A117.1 (ADA)



T&S BRASS AND BRONZE WORKS, INC.
 2 Saddleback Cove / P.O. Box 1088
 Travelers Rest, SC 29690

Model No.
B-0200

Item No.

Travelers Rest, SC: 800-476-4103 • Simi Valley, CA: 800-423-0150 • Fax: 864-834-3518 • www.tsbrass.com

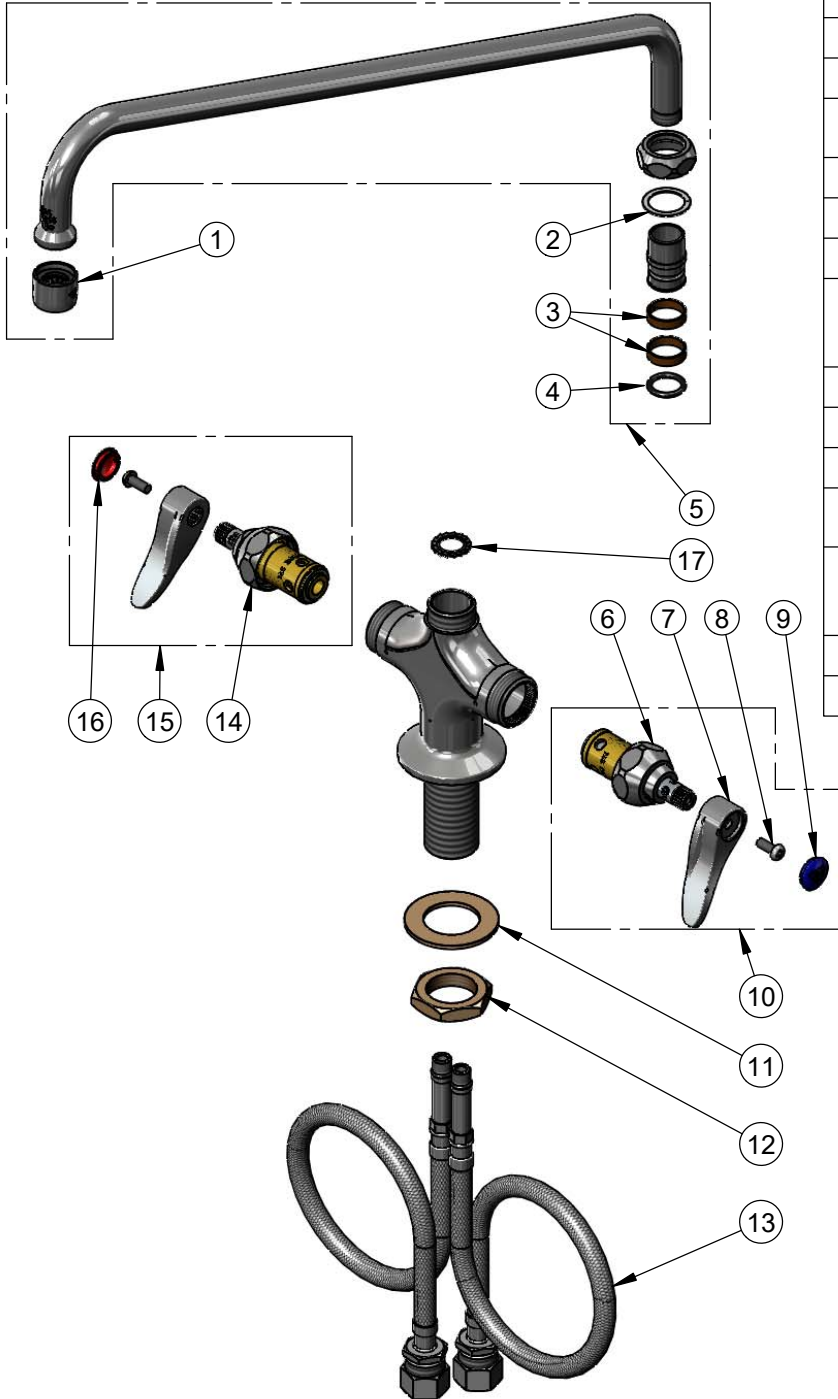

ITEM NO.	SALES NO.	DESCRIPTION
1	B-PT	Full Flow Stream Regulator
2	009538-45	Swivel Washer
3	011429-45	Swivel Sleeves (2)
4	001074-45	O-Ring
5	065X	18" Swing Nozzle
6	012442-40NS	Quarter-Turn Eterna Cartridge w/ Spring Check, LTC
7	001638-45NS	Lever Handle (New Style)
8	000925-45	Lab Handle Screw
9	018506-19NS	Blue Button Index, Press-in
10	002711-40NS	Quarter-Turn Eterna Cartridge w/ Spring Check, Handle, Blue Index & Screw, LTC
11	002290-45	Lock Washer
12	000965-45	Lock Nut
13	012534-45	18" Flexible Supply Hose (2)
14	012443-40NS	Quarter-Turn Eterna Cartridge w/ Spring Check, RTC
15	002712-40NS	Quarter-Turn Eterna Cartridge w/ Spring Check, Handle, Red Index & Screw, RTC
16	001193-19NS	Red Button Index, Press-in
17	014200-45	Star Washer, Anti-Rotation

Product Specifications:
 Single Hole Deck Mount Mixing Faucet, Quarter-Turn Eterna Cartridges w/ Spring Checks, Lever Handles, 18" Swing Nozzle & 18" Flexible Stainless Steel Supply Hoses w/ 1/2" NPSM Male Inlets

Product Compliance:
 ASME A112.18.1 / CSA B125.1
 NSF 61 - Section 9
 NSF 372 (Low Lead Content)
 ANSI A117.1 (ADA)