



T&S BRASS AND BRONZE WORKS, INC.

2 Saddleback Cove / P.O. Box 1088
Travelers Rest, SC 29690



REG. #A2601
ISO #9001

Model No.

006648-20R

Item No.

Travelers Rest, SC: 800-476-4103 Simi Valley, CA: 800-423-0150 Fax: 864-834-3518 www.tsbrass.com

This Space for Architect/Engineer Approval

Job Name _____ Date _____

Model Specified _____ Quantity _____

Customer/Wholesaler _____

Contractor _____

Architect/Engineer _____

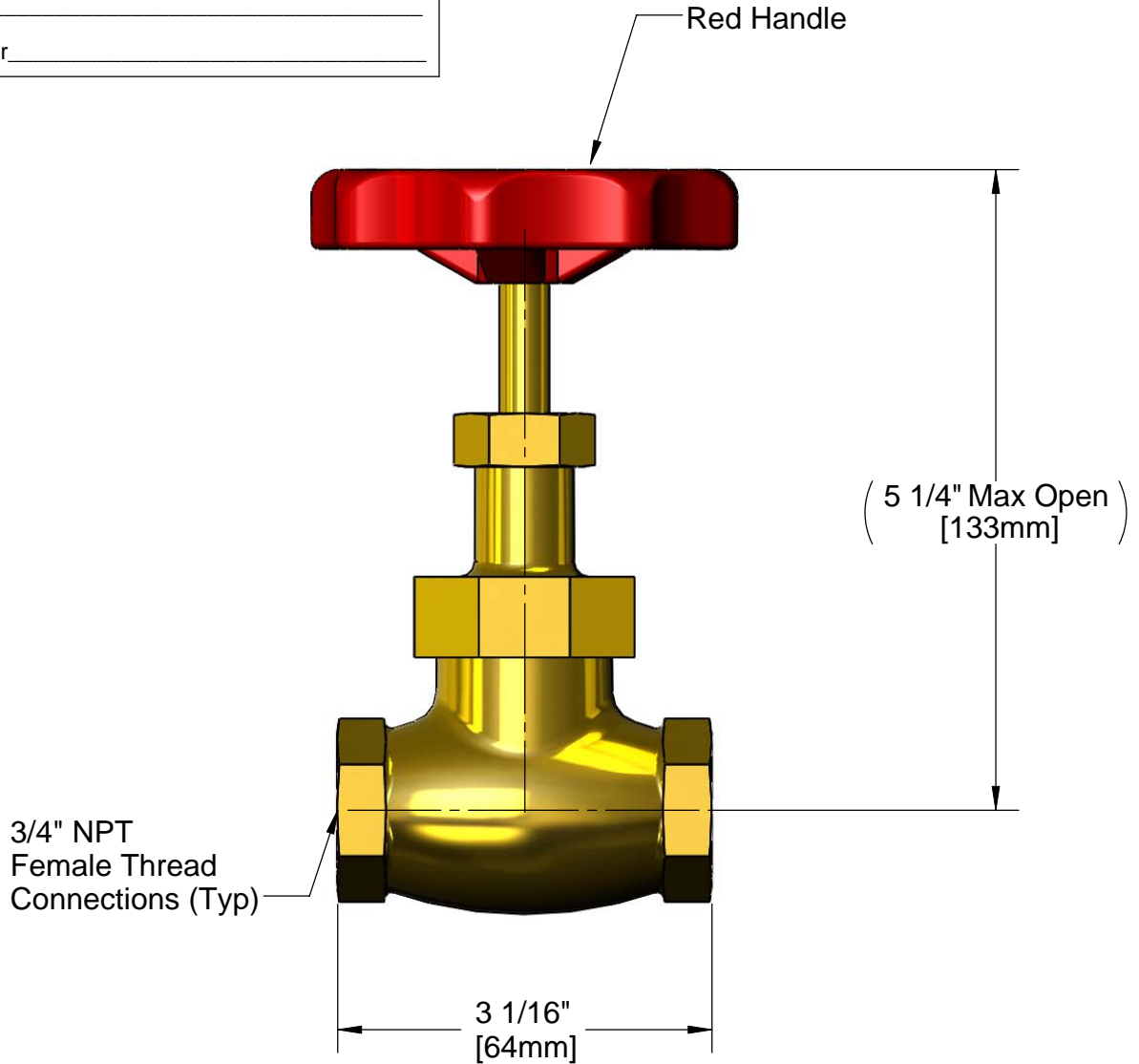

**NOTICE: THIS PRODUCT IS NOT DESIGNED AND/OR RATED FOR
POTABLE / DRINKING WATER APPLICATIONS**

Product Specifications:

**Bronze Globe Valve w/ 3/4" NPT Female Thread
Connections, Red Handle, Natural Finish**

Drawn DMH	Checked DHL	Approved JHB
Scale: NTS		Date: 10/07/09