



Architect/Engineering Specifications:

Chrome plated brass 1 1/2" nipple with 3/8" NPT male threads. Certified to NSF 61-Section 9 and NSF 372.

Job Name _____

Model Specified _____ Quantity _____

Variations Specified _____

Date _____

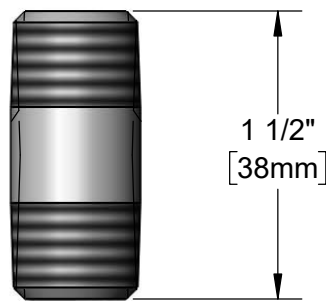

Features & Benefits:

- Chrome plated brass 1 1/2" nipple
- 3/8" NPT male threads
- Material: Polished chrome plated brass

Product Compliance:

- NSF 61 - Section 9
- NSF 372 (Low Lead Content)



Warranty: One Year (Limited)

Performance Data:

- N/A

