



# Rigid and Swivel Gooseneck Spouts

## B-0545-F15

TAG:

### Rigid/Swivel Gooseneck Spout

#### Architect/Engineering Specifications:

Deck mount rigid/swivel gooseneck with polished chrome plated brass deck flange and gooseneck with plain end outlet, 1.5 GPM flow disc in swivel piece and 1/2" NPSM male inlet. Certified to ASME A112.18.1/CSA B125.1, NSF 61-Section 9 and NSF 372.

Job Name \_\_\_\_\_  
 Model Specified \_\_\_\_\_ Quantity \_\_\_\_\_  
 Variations Specified \_\_\_\_\_  
 Date \_\_\_\_\_

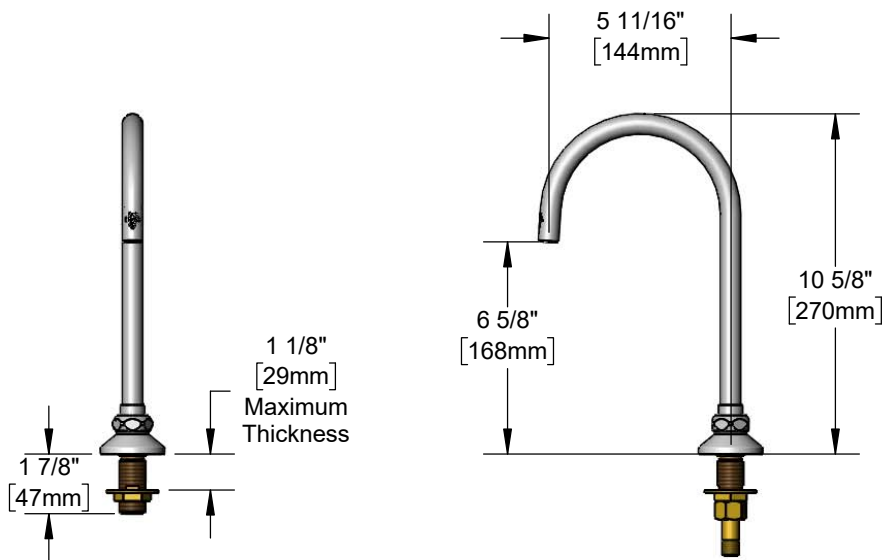
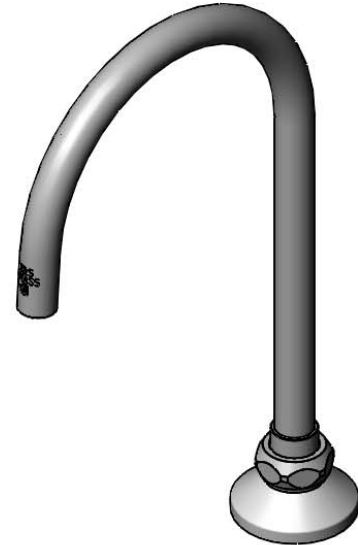

#### Features & Benefits:

- Deck mount rigid/swivel dummy gooseneck for remote locations
- 5 11/16" rigid/swivel gooseneck w/ plain end outlet
- Lock washer provided for rigid application
- 1.5 GPM flow disc in swivel piece
- 1/2" NPSM male inlet w/  $\phi$ 2" flange
- Tailpiece and nut for 1/4" NPT male connection
- Material: Polished chrome plated brass flange & tubular spout

#### Product Compliance:

- ASME A112.18.1 / CSA B125.1
- NSF 61 - Section 9
- NSF 372 (Low Lead Content)



#### Warranty: One Year (Limited)

#### Performance Data:

- Pressure: 20 - 125 psi [1.38 - 8.62 bar]
- Temperature: 40°F - 140°F [4.44°C - 60°C]
- Flow Rate: 1.5 GPM [5.7 L/min] @ 60 psi [4.14 bar]



T&S BRASS AND BRONZE WORKS, INC.



• 2 Saddleback Cove • Travelers Rest, SC 29690  
 Ph 800-476-4103 • Fax 864-834-3518  
 • Simi Valley, CA • Ph 800-423-0150 • www.tsbrass.com

Date: 06/12/20