



Epoxy Coated Retractable Hose Reel

B-7232-01-ESB36

TAG:

Open Epoxy Coated Hose Reel

Architect/Engineering Specifications:

Open epoxy coated steel hose reel, high flow spray valve with swivel, 3/8" x 35' heavy-duty non-marking hose, ratcheting system, multi-fit bracket, adjustable hose bumper, 3/8" NPT female inlet, 36" flexible water hose connector and universal stainless steel wall mount swing bracket with reel-to-bracket mounting hardware.

Job Name _____
 Model Specified _____ Quantity _____
 Variations Specified _____
 Date _____

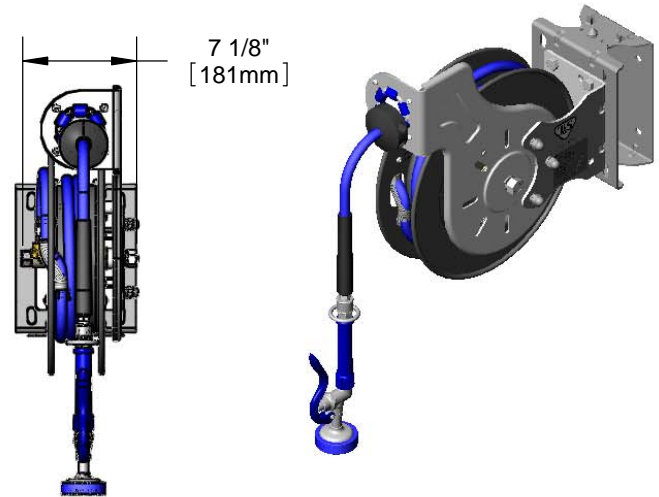
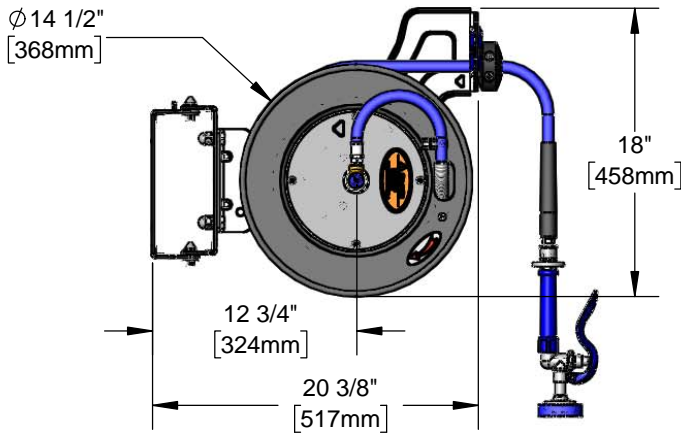

Features & Benefits:

- Open epoxy coated steel hose reel
- Blue high flow spray valve w/ swivel
- 3/8" x 35' heavy-duty non-marking hose rated to 300 PSI
- Ratcheting system holds the length of hose until a slight tug to retract automatically
- 3/8" NPT female inlet
- Adjustable hose bumper
- 36" flexible water hose connector
- Multi-fit bracket for wall, ceiling or under counter mounting
- 100 degree universal stainless steel wall mount swing bracket designed for one person installation with reel-to-bracket mounting hardware
- Material: Epoxy coated steel open reel and wall bracket, polished chrome plated spray valve, stainless steel swing bracket

Product Compliance:

- NSF 61 Exempt (Non-Potable)
- EPA Act 2005 Non-Compliant (PRSV)

Warranty: Two Year (Limited)

- Hose: One Year (Limited)

Performance Data:

- Pressure: 20 - 125 psi
- Temperature: 40 °F - 140 °F
- Flow Rate: 3.89 GPM @ 60 psi

Optional Hose Reel Spray Valves

- B-0107 Med Flow Spray Valve
- B-0108 Ergonomic Medium Flow Spray Valve
- B-0108-H Ergonomic High Flow Spray Valve
- EB-0107 High Flow Spray Valve (Standard)
- EB-2322 Extended Spray Wand
- MV-2516-24 Stainless Steel Rear Trigger Water Gun
- MV-2522-24 Stainless Steel Front Trigger Water Gun
- MV-3516-24 Aluminum Rear Trigger Water Gun

Optional Hose Reel Multi-Fit Brackets

3/8" x 15', 30', & 35' Epoxy Coated Hose Reel

- G019430-45 EasyInstall Stainless Steel Swing Bracket (Standard)
- G016636-45 Epoxy Coated Wall Swing Bracket
- G016652-45 Deck Mount Pivot Bracket
- G018477-45 Stainless Steel Table Leg Swing Bracket



T&S BRASS AND BRONZE WORKS, INC.



• 2 Saddleback Cove • Travelers Rest, SC 29690
 Ph 800-476-4103 • Fax 864-834-3518
 • Simi Valley, CA • Ph 800-423-0150 • www.tsbrass.com

Date: 10/09/17