



T&S BRASS AND BRONZE WORKS, INC.
 2 Saddleback Cove / P.O. Box 1088
 Travelers Rest, SC 29690

Model No.
BL-5735-01

Item No.

Travelers Rest, SC: 800-476-4103 • Simi Valley, CA: 800-423-0150 • Fax: 864-834-3518 • www.tsbrass.com

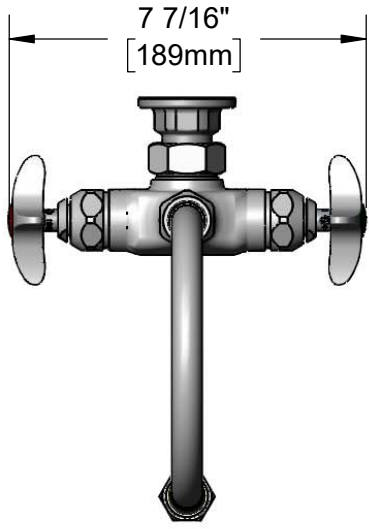

This Space for Architect/Engineer Approval

Job Name _____ Date _____

Model Specified _____ Quantity _____

Customer/Wholesaler _____

Contractor _____

Architect/Engineer _____

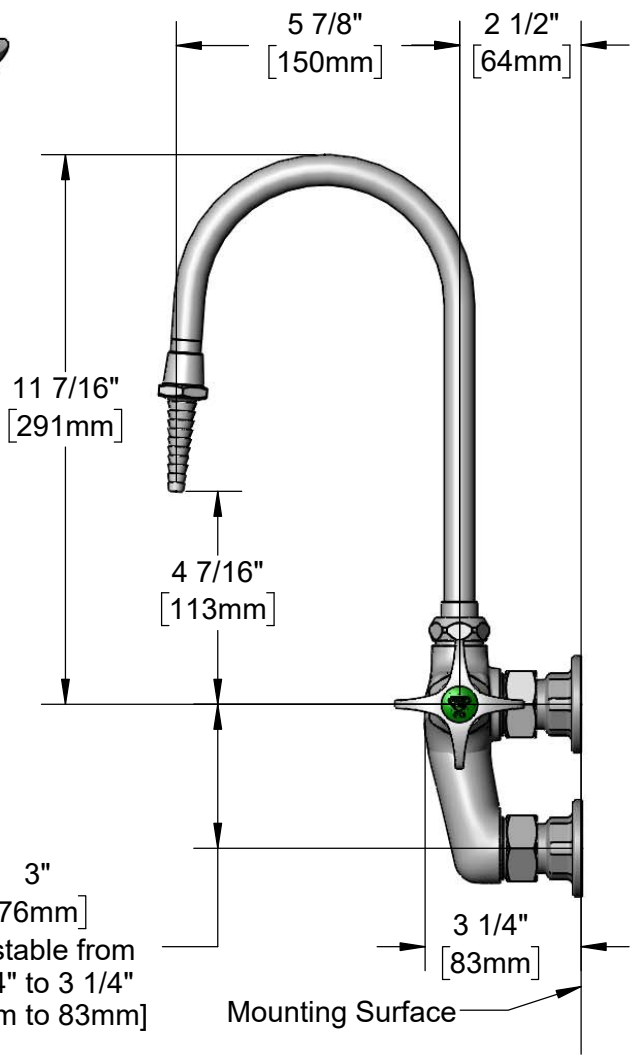
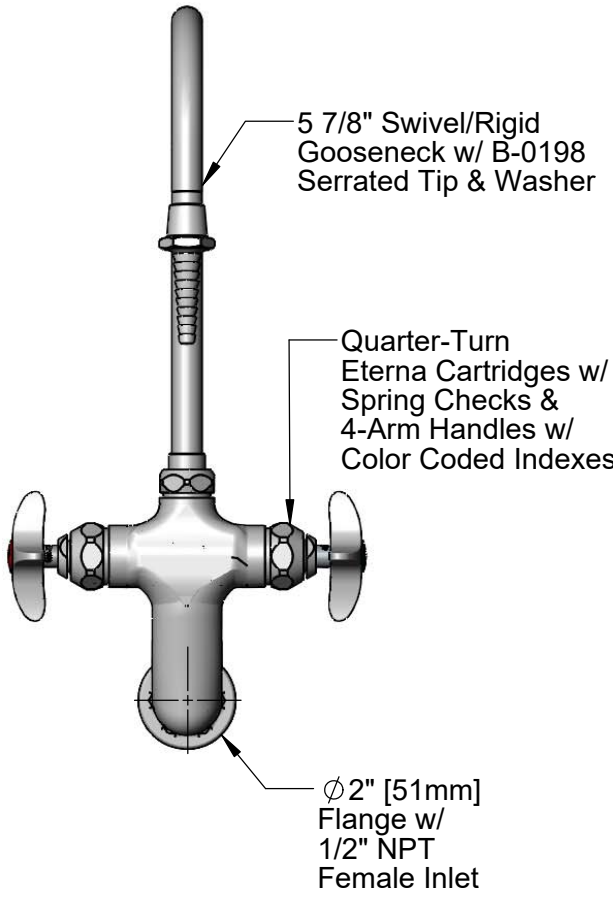
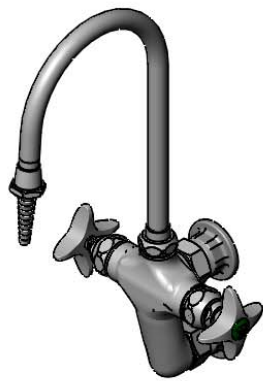

Product Specifications:
 Wall Mount Mixing Faucet, Quarter-Turn Eterna Cartridges w/ Spring Checks, 5 7/8" Swivel/Rigid Gooseneck w/ Serrated Tip, 4-Arm Lab Handles and 1/2" NPT Female Adjustable Inlets

Product Compliance:
 ASME A112.18.1 / CSA B125.1
 NSF 61 - Section 9
 NSF 372 (Low Lead Content)
 ANSI A117.1 (ADA)



T&S BRASS AND BRONZE WORKS, INC.

2 Saddleback Cove / P.O. Box 1088
Travelers Rest, SC 29690

Model No.

BL-5735-01

Item No.

Travelers Rest, SC: 800-476-4103 • Simi Valley, CA: 800-423-0150 • Fax: 864-834-3518 • www.tsbrass.com

ITEM NO.	SALES NO.	DESCRIPTION
1	B-0198	Serrated Tip w/ Washer
2	001051-45	Washer
3	009538-45	Swivel Washer
4	011429-45	Swivel Sleeves (2)
5	001074-45	O-Ring
6	014200-45	Star Washer, Anti-Rotation
7	001019-45	Coupling Nut Washer
8	00AA	1/2" NPT Female Eccentric Flange
9	001194-45NS	Red "HW" Lab Button Index
10	002521-45NS	4-Arm Handle (New Style)
11	012443-40NS	Quarter-Turn Eterna Cartridge w/ Spring Check, RTC
12	000925-45	Lab Handle Screw
13	001191-45NS	Green "CW" Lab Button Index

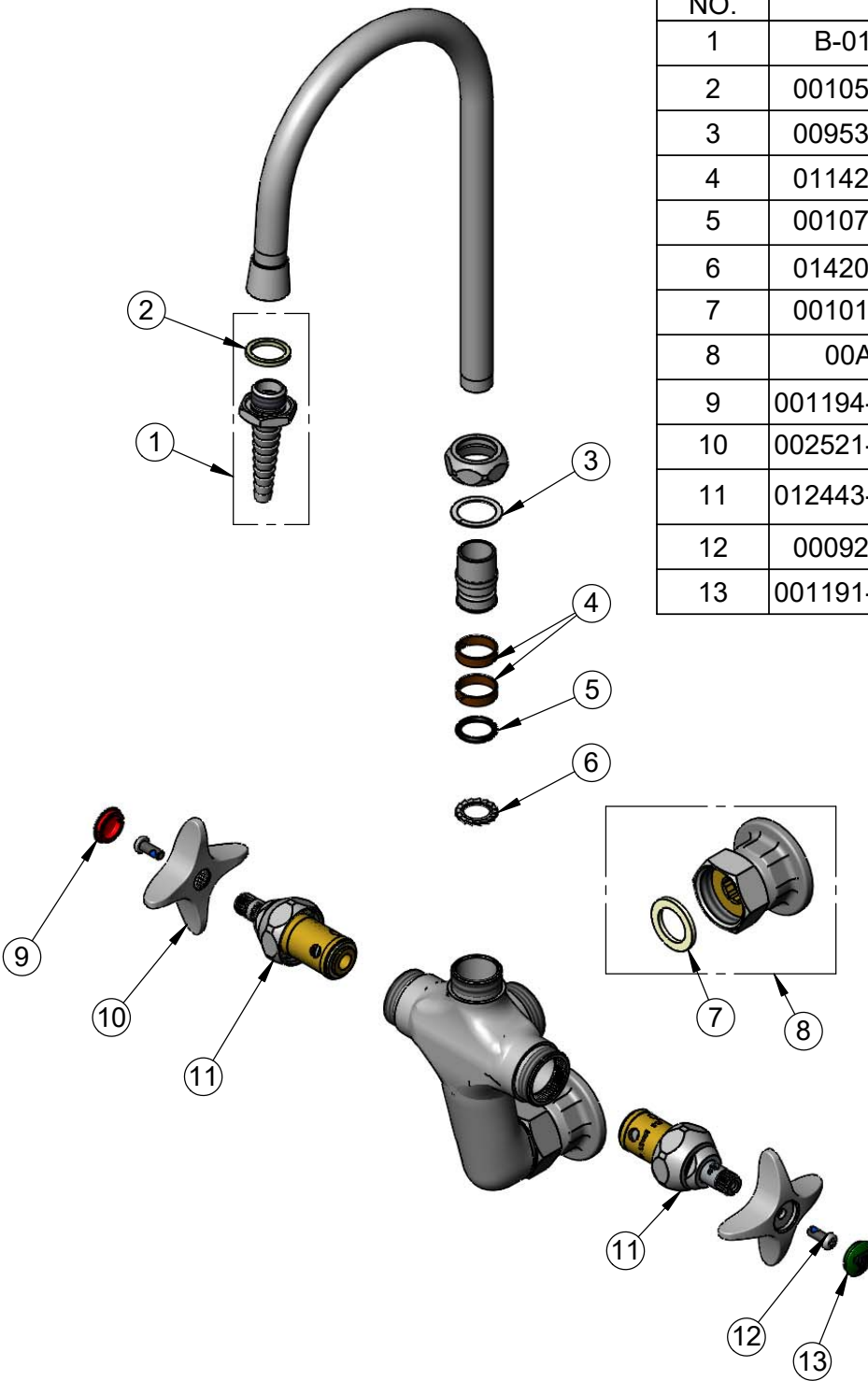

Product Specifications:

Wall Mount Mixing Faucet, Quarter-Turn Eterna Cartridges w/ Spring Checks, 5 7/8" Swivel/Rigid Gooseneck w/ Serrated Tip, 4-Arm Lab Handles and 1/2" NPT Female Adjustable Inlets

Product Compliance:

ASME A112.18.1 / CSA B125.1
NSF 61 - Section 9
NSF 372 (Low Lead Content)
ANSI A117.1 (ADA)