



Electronic Faucets

EC-3142-4DP

TAG:



ChekPoint™ Electronic Sensor Faucet

Architect/Engineering Specifications:

Single hole deck mount electronic sensor faucet with polished chrome plated brass body and integral spout, 2.2 GPM vandal resistant aerator, 4" deck plate, above deck electronic AC/DC control module with internal flow control setting switches, above deck temperature mixing handle, 18" flexible stainless steel supply hoses and check valve adapters with 3/8" compression connections. Certified to ASME A112.18.1/CSA B125.1, NSF 61-Section 9, NSF 372 and UL 1951. Meets ADA ANSI/ICC A117.1 requirements.

Job Name _____
 Model Specified _____ Quantity _____
 Variations Specified _____
 Date _____

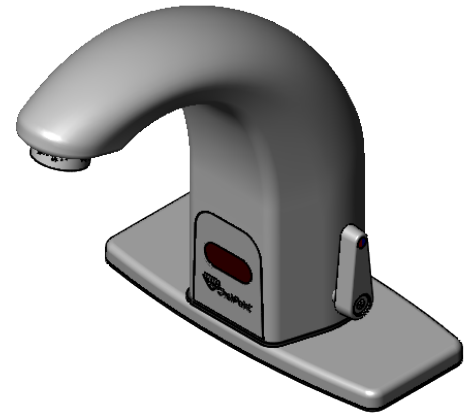
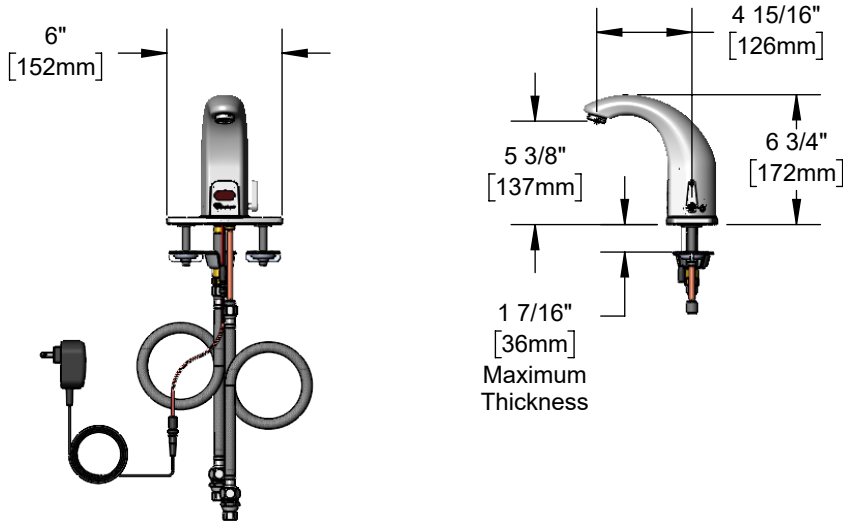

Features & Benefits:

- Single hole deck mount faucet with polished chrome plated brass body
- 2.2 GPM vandal resistant aerator, Series 8 (B-0199-08)
- 4" forged deck plate w/ gasket & hardware
- Above deck electronic module w/ internal flow control switches for adjusting auto time out & shut off delay settings
- Optional auto flush feature flows water for 30 seconds after every 12 inactive hours
- Optional metering mode
- Plug in AC transformer or 6 VDC lithium battery (DC) power options
- Above deck temperature mixing handle
- 18" flexible stainless steel supply hoses with filter washers
- Check valve adapters with 3/8" compression connections
- Low battery LED indicator light
- Material: Polished chrome plated brass body & deck plate

Product Compliance:

- ASME A112.18.1 / CSA B125.1
- NSF 61 - Section 9
- NSF 372 (Low Lead Content)
- ANSI A117.1 (ADA)
- UL 1951



ADA Compliant

Warranty: Three Year (Limited)

Performance Data:

- Pressure: 20 - 125 psi [1.38 - 8.62 bar]
- Temperature: 40°F - 140°F [4.44 C - 60 C]
- Flow Rate: 2.2 GPM [8.3 L/min] @ 60 psi [4.14 bar]
- Water Consumption: @ 10 sec = .37 gal [1.40 L]
@ 15 sec = .55 gal [2.08 L]



Optional Outlets (Series 3 / VR Series 8)

GPM	Aerated	Non-Aerated (Laminar)	VR Aerated	VR Non-Aerated (VR Laminar)
0.35	N/A	<input type="checkbox"/> B-0199-03-N035	N/A	<input type="checkbox"/> B-0199-08-N035
0.5	N/A	<input type="checkbox"/> B-0199-03-N05	N/A	<input type="checkbox"/> B-0199-08-N05
1.0	N/A	N/A	N/A	<input type="checkbox"/> B-0199-08-LF10
1.5	<input type="checkbox"/> B-0199-03-WS	N/A	<input type="checkbox"/> B-0199-08-WS	<input type="checkbox"/> B-0199-08-LF15
2.2	<input type="checkbox"/> B-0199-03	<input type="checkbox"/> B-0199-26	Standard	<input type="checkbox"/> B-0199-28

Optional Deck Plates

- 4" Chrome Plated Brass Deck Plate (Standard)
- 8" Chrome Plated Brass Deck Plate



T&S BRASS AND BRONZE WORKS, INC.



• 2 Saddleback Cove • Travelers Rest, SC 29690
 Ph 800-476-4103 • Fax 864-834-3518
 • Simi Valley, CA • Ph 800-423-0150 • www.tsbrass.com

Date: 11/01/23