

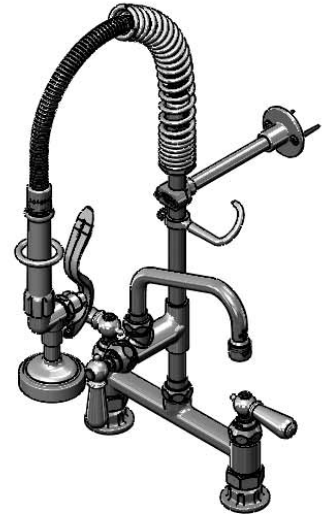

Architect/Engineering Specifications:

8" deck mount mixing faucet with polished chrome plated brass body, add-on faucet with compression cartridge and club handle, 6" swing nozzle with stream regulator outlet, 8" riser, 24" flexible stainless steel hose with heat resistant handle, 1.15 GPM spray valve, compression cartridges with spring checks, club handles, 1/2" NPT female inlets, 6" adjustable wall bracket, spray valve holder and overhead spring. Certified to ASME A112.18.1/CSA B125.1, NSF 61-Section 9 and NSF 372. 2019 DOE PRSV - Class II compliant.

Job Name _____
Model Specified _____ Quantity _____
Variations Specified _____
Date _____

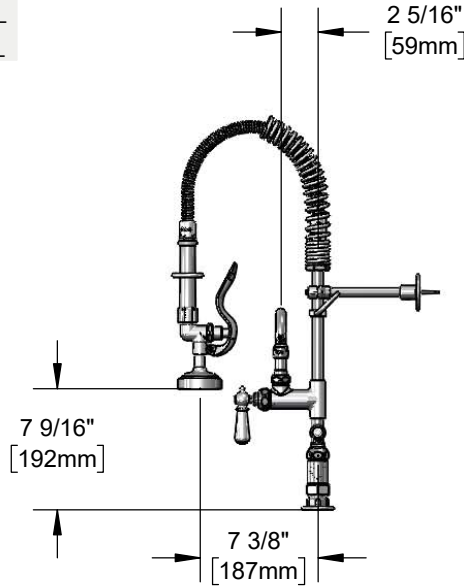
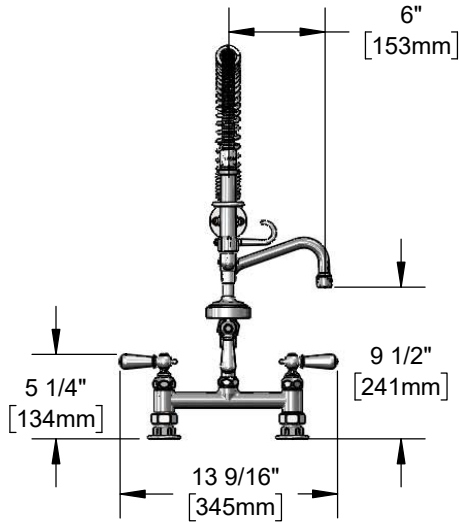

Features & Benefits:

- 8" deck mount mixing faucet w/ polished chrome plated brass body
EasyInstall add-on faucet w/ polished chrome plated brass body
6" swing nozzle w/ stream regulator outlet, Series 1
8" riser
24" flexible stainless steel hose w/ heat resistant gray handle and hold down ring
1.15 GPM spray valve
Quarter-turn Eterna compression cartridges w/ spring checks to prevent cross flow of water
Decorative club handles w/ chrome plated indexes
1/2" NPT female eccentric inlets w/ 2 inch flanges
Adjustable centers from 7 3/4" to 8 1/4"
6" adjustable wall bracket
Material: Polished chrome plated brass body, tubular nozzle, add-on faucet body, riser & spray valve, stainless steel hose and chrome plated metal handles

Product Compliance:

- ASME A112.18.1 / CSA B125.1
NSF 61 - Section 9
NSF 372 (Low Lead Content)
2019 DOE PRSV - Class II
For Commercial Use Only



Warranty: Three Year (Limited)

Performance Data:

- Pressure: 20 - 125 psi
Temperature: 40 F - 140 F
Flow Rate:
Spray Valve: 1.15 GPM @ 60 psi
Add-On Faucet: 5.35 GPM @ 60 psi

Optional Cartridges With Checks

- Quarter-Turn Cerama w/ Check Valve
Quarter-Turn Eterna w/ Spring Check (Standard)

Optional Handles

- 4" Wrist Action
Lever
4-Arm

Optional Pre-Rinse Spray Valves

- B-0107 (1.15 GPM) (Standard)
B-0107-C (0.65 GPM)
B-0107-J (1.07 GPM)
B-0108 (1.07 GPM)
B-0108-C (0.65 GPM)

Optional Add-On Faucet Outlets (Series 1 / VR Series 6)

Table with 3 columns: GPM, Aerated, VR Aerated (VR Laminar). Rows include GPM values 1.0, 1.5, 2.2 and corresponding aerated and VR aerated options.

