

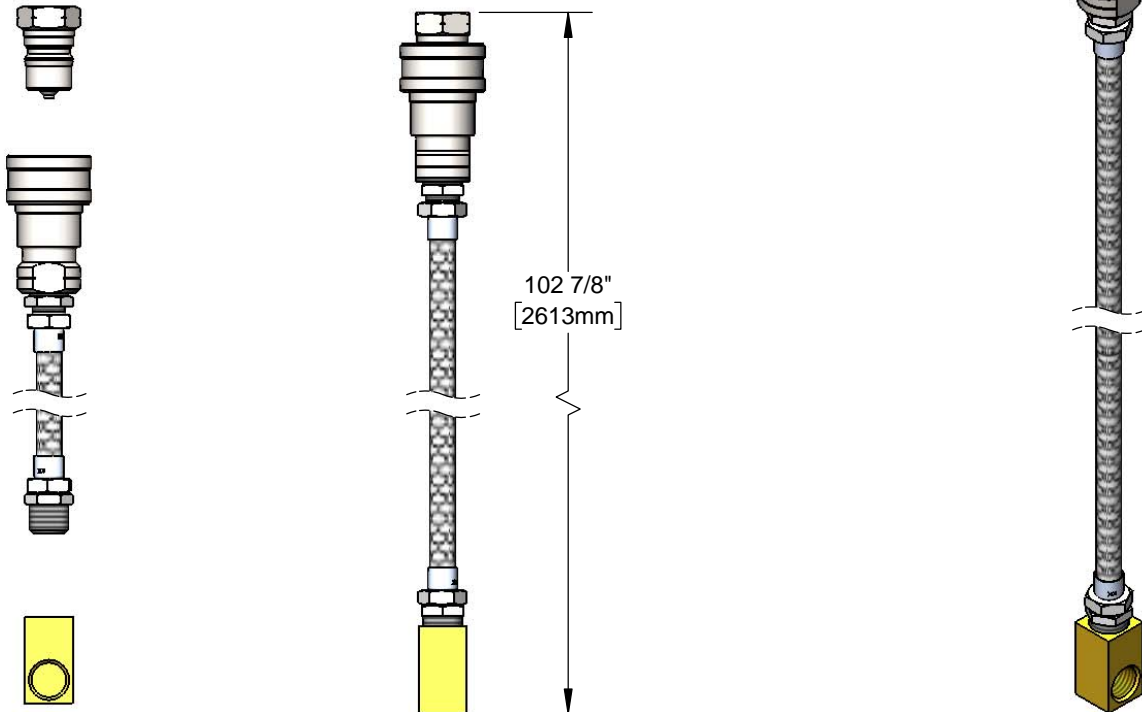

Architect/Engineering Specifications:

8' flexible hose assembly with FDA food grade PVC hose, 1/2" NPT female stainless steel quick disconnect coupling and 1/2" NPT female brass short elbow. Certified to ASME A112.18.1/CSA B125.1, NSF 61-Section 9 and NSF 372.

Job Name _____
 Model Specified _____ Quantity _____
 Variations Specified _____
 Date _____



Features & Benefits:

- 8' flexible FDA food grade reinforced PVC hose
- 1/2" NPT female stainless steel quick disconnect coupling
- 1/2" NPT female brass short elbow
- Material: PVC hose, stainless steel coupling and brass elbow

Product Compliance:

- ASME A112.18.1 / CSA B125.1
- NSF 61 - Section 9
- NSF 372 (Low Lead Content)



Warranty: One Year (Limited)



Performance Data:

- Pressure: 20 - 125 psi
- Temperature: 40 °F - 140 °F
- Flow Rate: 5.88 GPM @ 60 psi

