



Gas Hoses
HG-6D-60S

TAG:

SAFETY-LINK Gas Hose

Architect/Engineering Specifications:

60" coated gas appliance connector hose with 3/4" NPT male connections, 2-piece reverse quick disconnect, (2) swivel-links fittings & (2) 90° elbows. Certified to ANSI Z21.69/CSA 6.16 and NSF 2.

Job Name _____
 Model Specified _____ Quantity _____
 Variations Specified _____
 Date _____

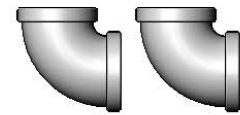
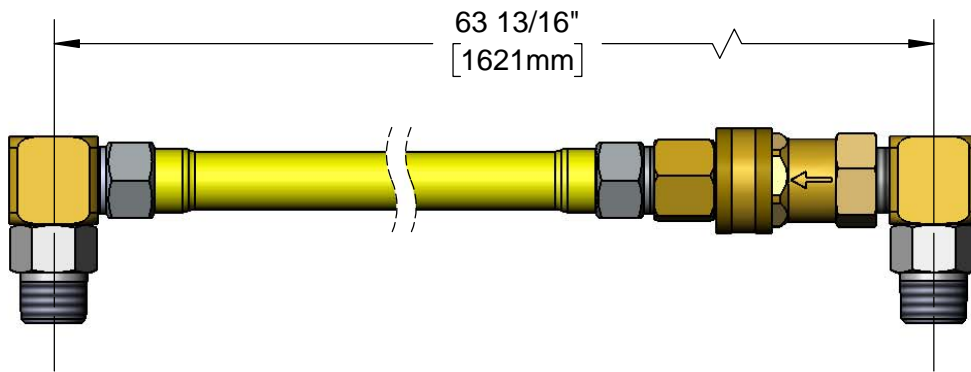
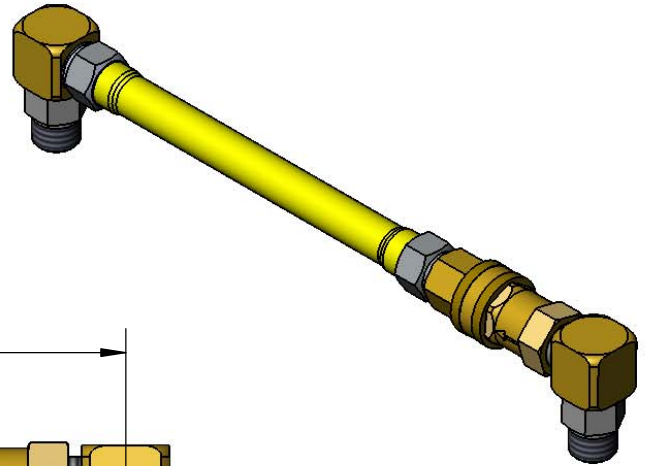

90° Elbows



Features & Benefits:

- 60" coated gas appliance connector
- 3/4" NPT male freespin inlet
- 3/4" NPT male freespin outlet
- 3/4" NPT female reverse quick-disconnect
- Reverse quick-disconnect socket acts as a shut-off valve when the plug and socket are disconnected
- (2) 3/4" NPT swivel-links fittings
- (2) 3/4" NPT 90° elbow
- 360° rotatable hex nut rotates completely and freely
- Optimum torsional relief improves safety, increases connector life
- Provides efficient, full gas flow
- Material: Extruded coated stainless steel braids

Product Compliance:

- ANSI Z21.69 / CSA 6.16
- NSF 2
- NFPA 54

Warranty: Five Year (Limited)

Performance Data:

- Gas Pressure: 1/2 psi max
- Temperature: 350 °F max w/ fuseable link thermal shut-off
- Capacity: 160,000 BTU/ hr min



T&S BRASS AND BRONZE WORKS, INC.



• 2 Saddleback Cove • Travelers Rest, SC 29690
 Ph 800-476-4103 • Fax 864-834-3518
 • Simi Valley, CA • Ph 800-423-0150 • www.tsbrass.com

Date: 06/23/17