



Architect/Engineering Specifications:

Modular push-pull waste valve for 3 1/2" sink opening with stainless steel body, 2" NPT male x 1 1/2" NPT male adapter, push-pull handle with chrome plated metal handle guard, 3 1/2" snap-in removable strainer and overflow tube with head assembly and cap. Certified to ASME A112.18.2/CSA B125.2

Job Name _____

Model Specified _____ Quantity _____

Variations Specified _____

Date _____

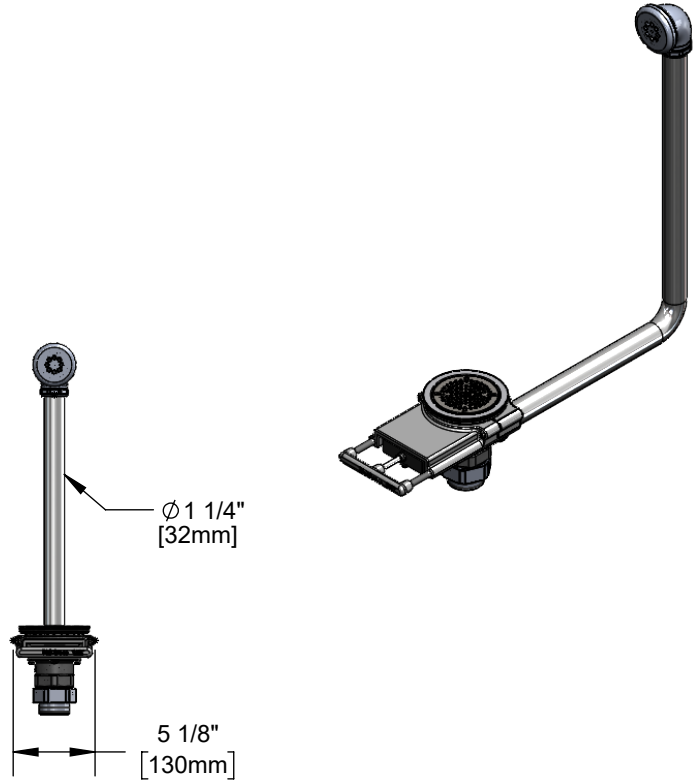
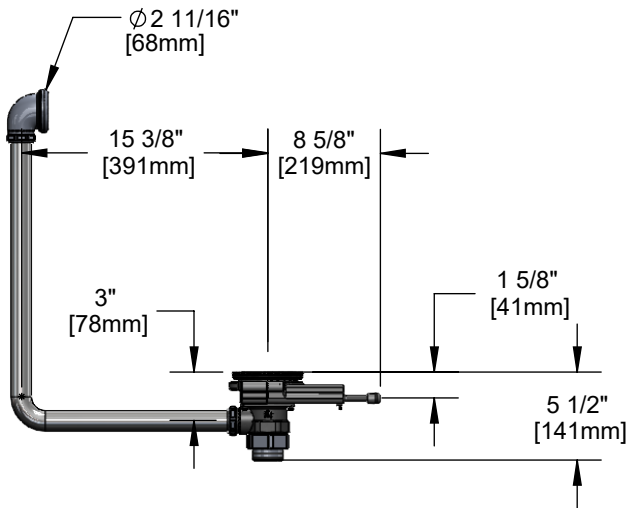

Features & Benefits:

- Modular push-pull waste valve for 3 1/2" sink opening w/ stainless steel body
- Modular design for easy installation and maintenance
- 2" NPT male outlet x 1 1/2" NPT male adapter
- Push-pull handle with handle guard to endure extreme abuse
- 3 1/2" snap-in removable strainer
- Overflow tube w/ head assembly and sealing cap
- Installation tool included
- 3" handle extension included
- Material: Stainless steel body, stainless steel flat strainer and chrome plated metal handle guard

Product Compliance:

- ASME A112.18.2 / CSA B125.2



Warranty: Lifetime (Limited)

Performance Data:

- Discharge Rate: 28.50 GPM [107.88 L/min] max
- Temperature: 40°F - 180°F [4.44°C - 82.22°C]

