



T&S BRASS AND BRONZE WORKS, INC.
 2 Saddleback Cove / P.O. Box 1088
 Travelers Rest, SC 29690

Model No.
161X

Item No.

Travelers Rest, SC: 800-476-4103 • Simi Valley, CA: 800-423-0150 • Fax: 864-834-3518 • www.tsbrass.com

This Space for Architect/Engineer Approval

Job Name _____ Date _____

Model Specified _____ Quantity _____

Customer/Wholesaler _____

Contractor _____

Architect/Engineer _____

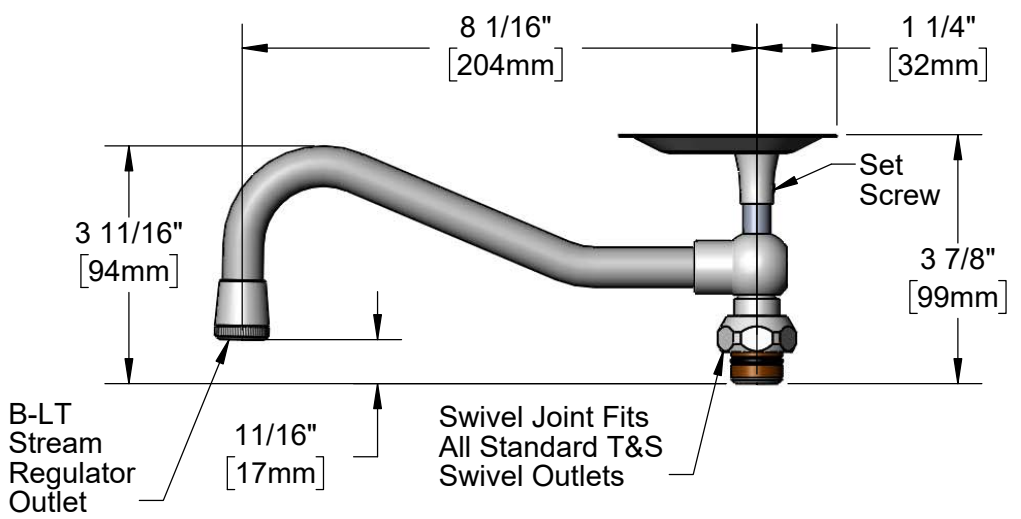
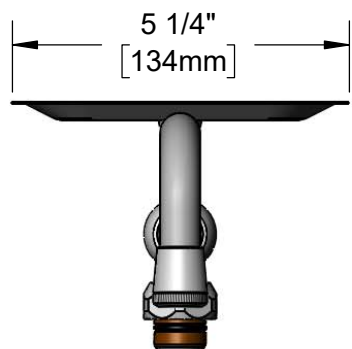
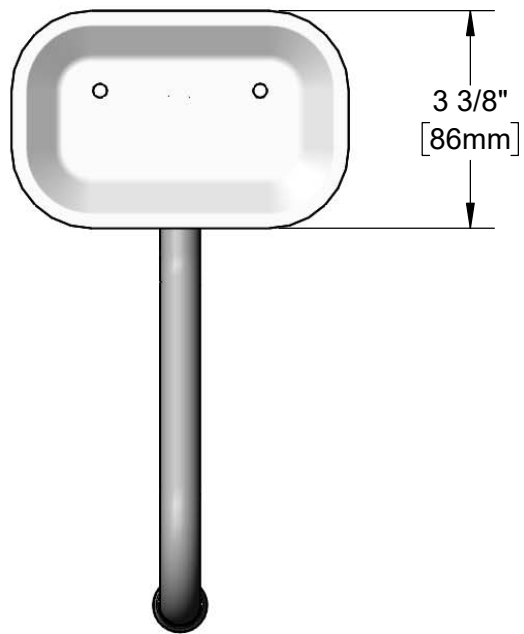

Product Specifications:
 8 1/16" Swing Nozzle w/ Soap Dish

Product Compliance:
 ASME A112.18.1 / CSA B125.1
 NSF 61 - Section 9
 NSF 372 (Low Lead Content)



T&S BRASS AND BRONZE WORKS, INC.
 2 Saddleback Cove / P.O. Box 1088
 Travelers Rest, SC 29690

Model No.
161X

Item No.

Travelers Rest, SC: 800-476-4103 • Simi Valley, CA: 800-423-0150 • Fax: 864-834-3518 • www.tsbrass.com

ITEM NO.	SALES NO.	DESCRIPTION
1	B-LT	Stream Regulator Outlet
2	001043-45	Washer
3	020205-40	Adapter, 5/8-27 UN x 3/8-18 NPSM
4	000286-40	8" Nozzle
5	000939-45	Set Screw
6	B-SD	Soap Dish
7	009538-45	Swivel Washer
8	000843-25	Swivel Body
9	011429-45	Swivel Sleeves (2)
10	001074-45	O-Ring

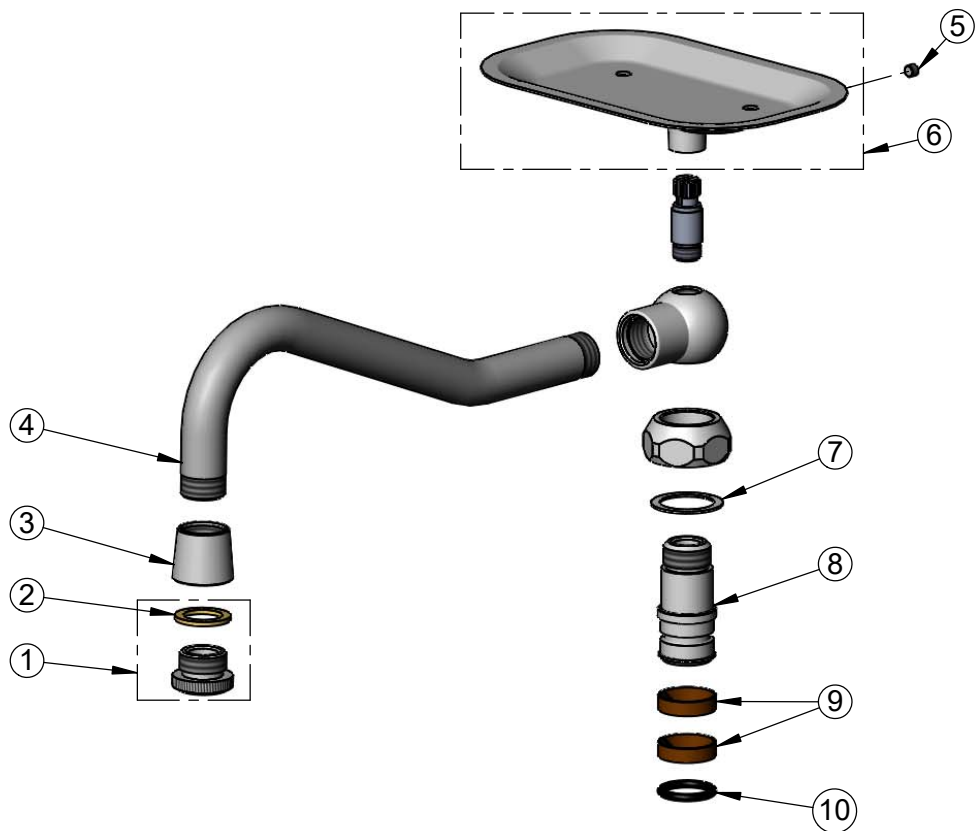

Product Specifications:
 8 1/16" Swing Nozzle w/ Soap Dish

Product Compliance:
 ASME A112.18.1 / CSA B125.1
 NSF 61 - Section 9
 NSF 372 (Low Lead Content)