



T&S BRASS AND BRONZE WORKS, INC.
 2 Saddleback Cove / P.O. Box 1088
 Travelers Rest, SC 29690

Model No.
110X

Item No.

Travelers Rest, SC: 800-476-4103 • Simi Valley, CA: 800-423-0150 • Fax: 864-834-3518 • www.tsbrass.com

This Space for Architect/Engineer Approval

Job Name _____ Date _____

Model Specified _____ Quantity _____

Customer/Wholesaler _____

Contractor _____

Architect/Engineer _____

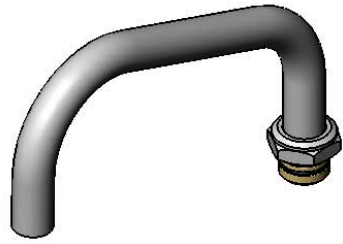

Swivel Nut Fits
 All T&S Big-Flo
 Swivel Outlets

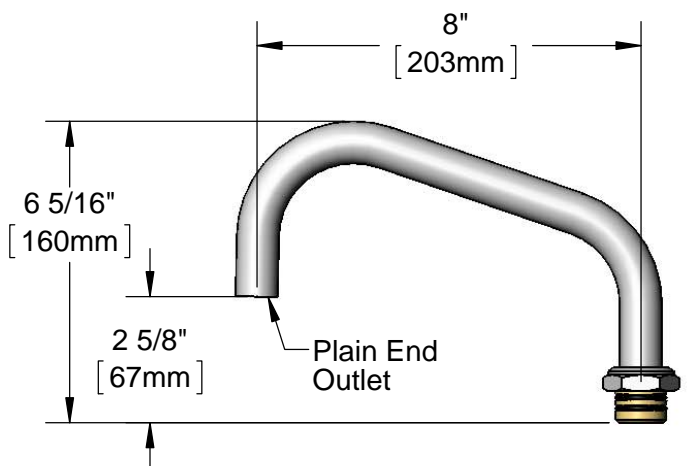

Product Specifications:
 8" Big-Flo Swing Nozzle w/ Plain End Outlet

Product Compliance:
 ASME A112.18.1 / CSA B125.1
 NSF 61 - Section 9
 NSF 372 (Low Lead Content)