



**Hand Sinks**  
**HS-1715-4W**

TAG:

*Hand Sink*

**Architect/Engineering Specifications:**

Stainless steel wall-mounted hand sink with backsplash, 3 1/2" drain that adapts to 1 1/2" drain pipe, mounting bracket and two 1" holes in the backsplash for a 4" wall mount faucet. Certified to ASME A112.19.3 / CSA B45.4 and ASME A112.18.2 / CSA B125.2.

Job Name \_\_\_\_\_  
 Model Specified \_\_\_\_\_ Quantity \_\_\_\_\_  
 Variations Specified \_\_\_\_\_  
 Date \_\_\_\_\_

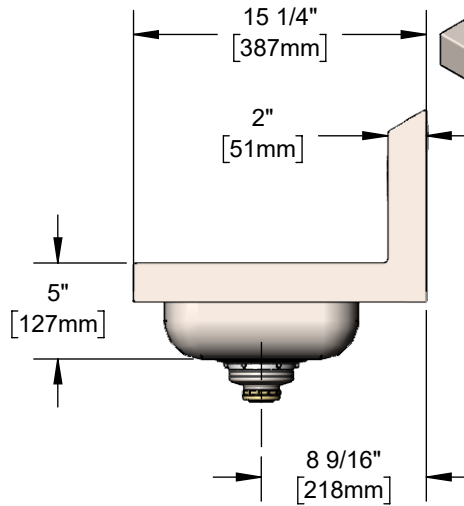
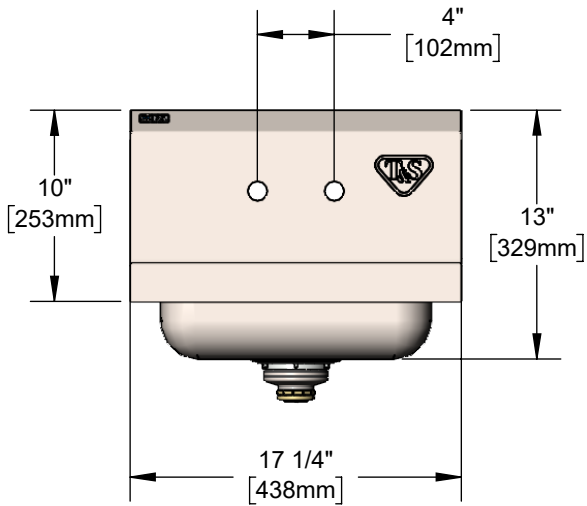

**Features & Benefits:**

- Stainless steel wall-mounted hand sink
- Backsplash w/ two 1" holes for 4" wall mounted faucets
- Mounting bracket is included
- 3 1/2" drain adapts to 1 1/2" drain pipe
- Material: Stainless steel sink

**Product Compliance:**

- ASME A112.19.3 / CSA B45.4 (Sink & Drain)
- NSF / ANSI 2 (Sink & Drain)
- ASME A112.18.2 / CSA B125.2 (Drain)



**Warranty:** One Year (Limited)

**Performance Data:**

- Discharge Rate: 18.00 GPM [68.14 L/min] max



**T&S BRASS AND BRONZE WORKS, INC.**



• 2 Saddleback Cove • Travelers Rest, SC 29690  
 Ph 800-476-4103 • Fax 864-834-3518  
 • Simi Valley, CA • Ph 800-423-0150 • www.tsbrass.com

Date: 11/06/24