



T&S BRASS AND BRONZE WORKS, INC.
 2 Saddleback Cove / P.O. Box 1088
 Travelers Rest, SC 29690

Model No.
EX-1WWF14

Item No.

Travelers Rest, SC: 800-476-4103 • Simi Valley, CA: 800-423-0150 • Fax: 864-834-3518 • www.tsbrass.com

This Space for Architect/Engineer Approval

Job Name _____ Date _____
 Model Specified _____ Quantity _____
 Customer/Wholesaler _____
 Contractor _____
 Architect/Engineer _____

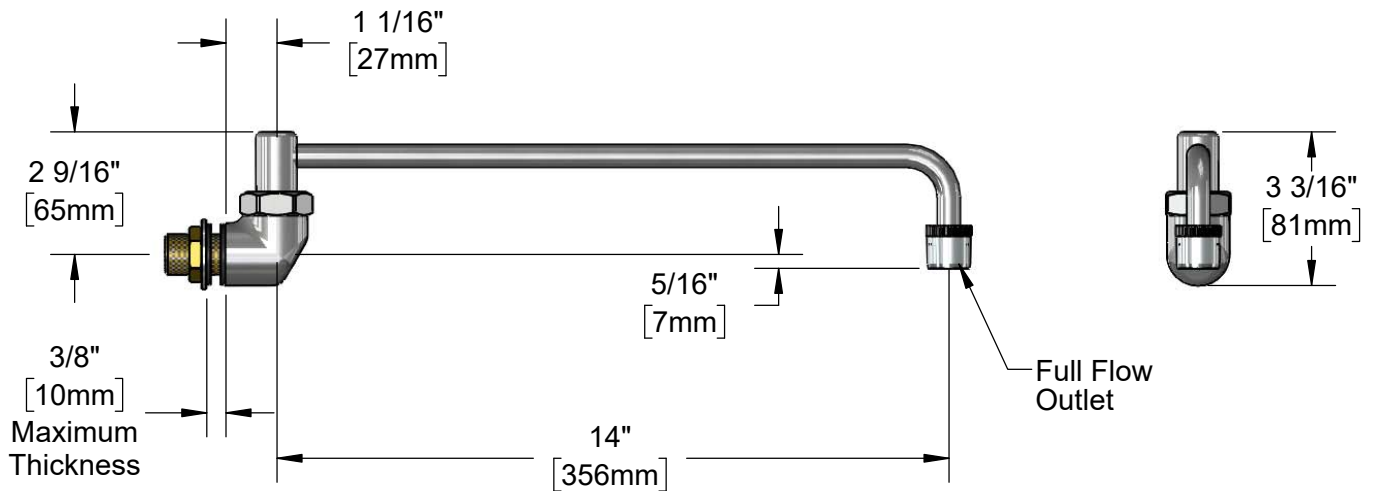
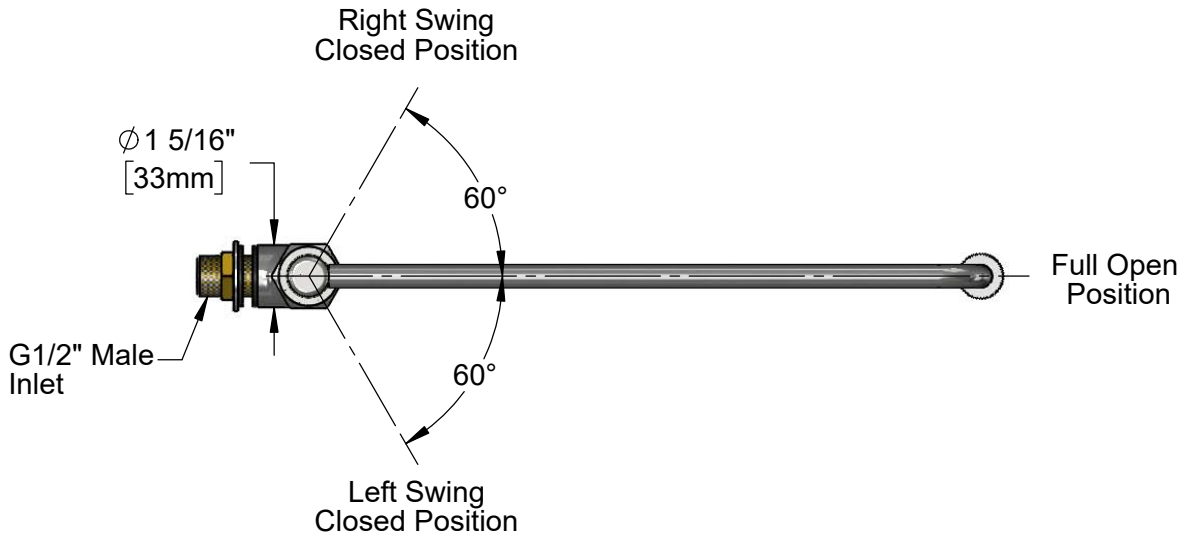

Rough-in Requirement:
 $\phi 1''$ [25mm] Mounting Hole

Product Specifications:
 Wok/Range Faucet w/ 14" Swing Nozzle, Full Flow Outlet & G1/2" Male Inlet

Product Compliance: