



T&S BRASS AND BRONZE WORKS, INC.

2 Saddleback Cove / P.O. Box 1088
Travelers Rest, SC 29690

Model No.

EX-6WP00-H

Item No.

Travelers Rest, SC: 800-476-4103 • Simi Valley, CA: 800-423-0150 • Fax: 864-834-3518 • www.tsbrass.com

This Space for Architect/Engineer Approval

Job Name _____ Date _____

Model Specified _____ Quantity _____

Customer/Wholesaler _____

Contractor _____

Architect/Engineer _____

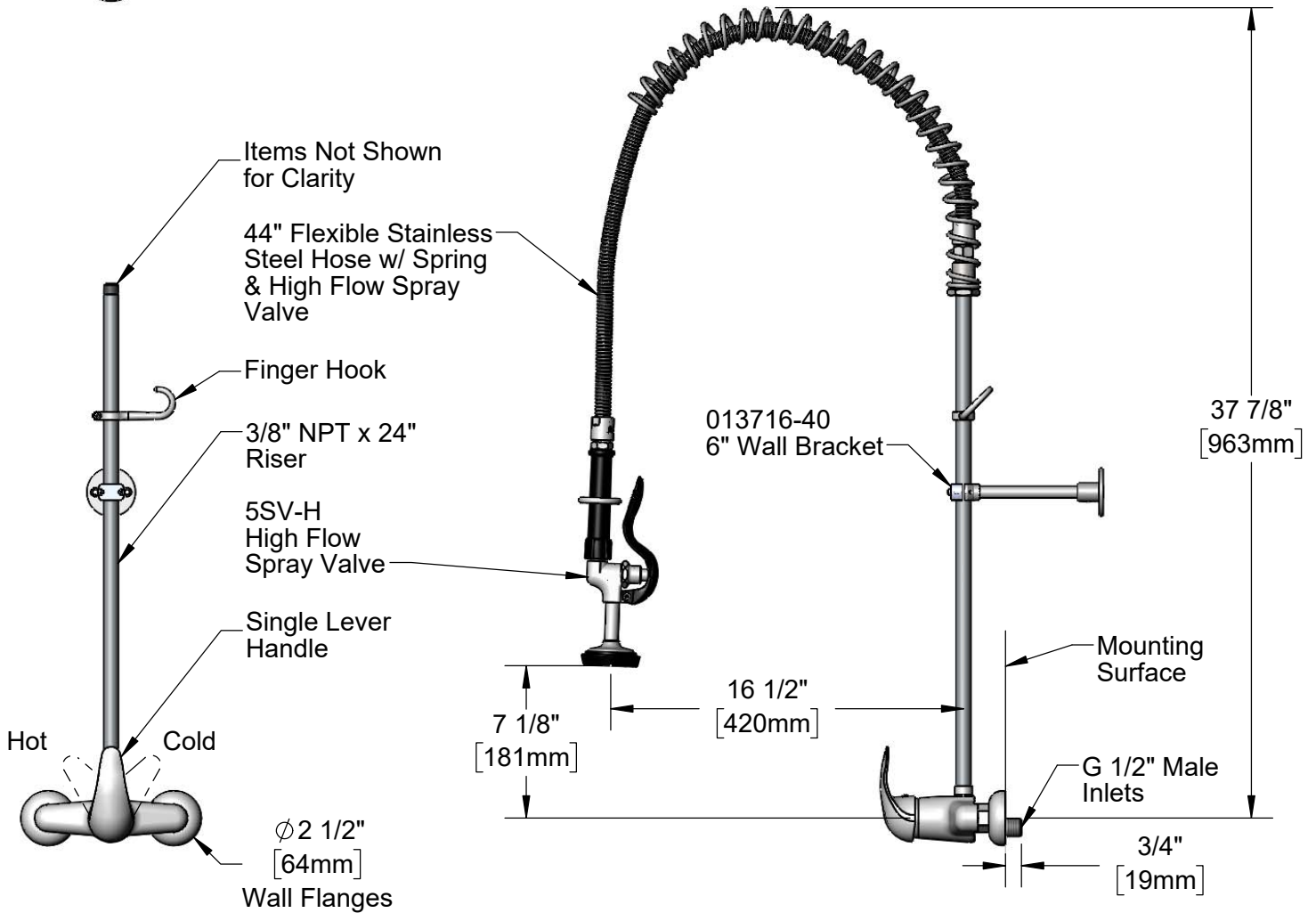
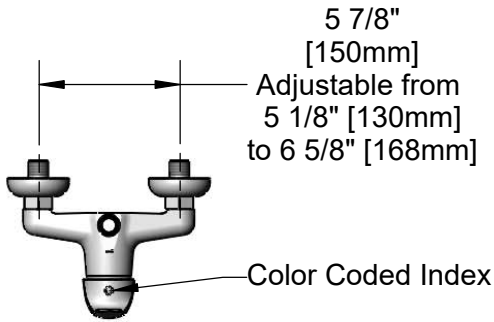

Rough-In Requirement:
(2) Ø 1" [25mm] Mounting Holes

Product Specifications:

Pre-Rinse Unit: Single Lever Wall Mount Base Faucet, 24" Riser, 44" Flexible Stainless Steel Hose, High Flow Spray Valve, 6" Wall Bracket & G 1/2" Male Inlets

Product Compliance:



T&S BRASS AND BRONZE WORKS, INC.
 2 Saddleback Cove / P.O. Box 1088
 Travelers Rest, SC 29690

Model No.
EX-6WP00-H

Item No.

Travelers Rest, SC: 800-476-4103 • Simi Valley, CA: 800-423-0150 • Fax: 864-834-3518 • www.tsbrass.com

ITEM NO.	SALES NO.	DESCRIPTION
1	5SV-H	equip High Flow Spray Valve
2	010476-45	#27 Washer
3	000907-45	Spray Valve Hold Down Ring
4	5HSE44	equip 44" Flexible Stainless Steel Hose
5	014068-45	Overhead Spring
6	000821-40	Spring Body
7	004R	Finger Hook
8	013716-40	6" Wall Bracket
9	000372-40	3/8" NPT x 24" Nipple
10	019215-45	40mm S/L Ceramic Cartridge (Tall)
11	019313-45	Single Lever Handle, Less Logo

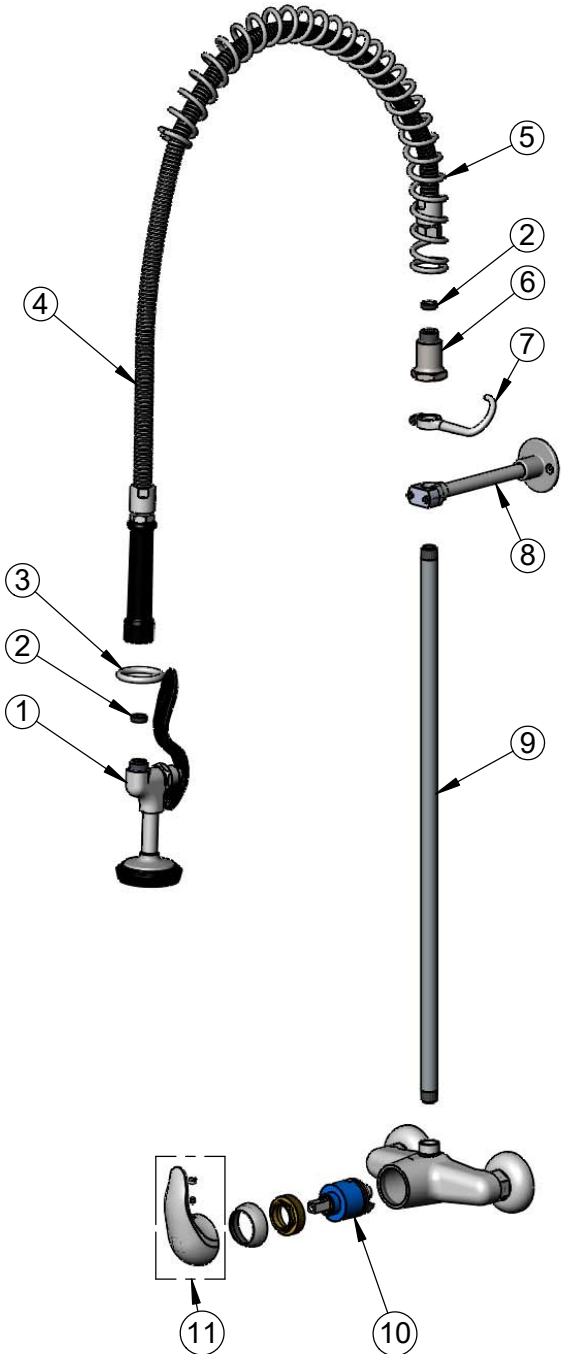

Product Specifications:
 Pre-Rinse Unit: Single Lever Wall Mount Base Faucet, 24" Riser, 44" Flexible Stainless Steel Hose, High Flow Spray Valve, 6" Wall Bracket & G 1/2" Male Inlets

Product Compliance: