



# Faucets

## 5F-8DLX16

TAG:

### 8" Deck Mount Faucet

#### Architect/Engineering Specifications:

8" deck mount mixing faucet with polished chrome plated brass body, 16" swing nozzle with laminar full flow device, ceramic cartridges, lever handles and 1/2" NPT female inlets. Certified to ASME A112.18.1/CSA B125.1, NSF 61-Section 9 and NSF 372. Meets ADA ANSI/ICC A117.1 requirements.

Job Name \_\_\_\_\_  
 Model Specified \_\_\_\_\_ Quantity \_\_\_\_\_  
 Variations Specified \_\_\_\_\_  
 Date \_\_\_\_\_

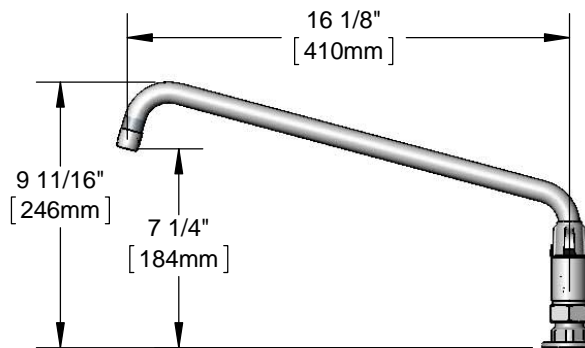
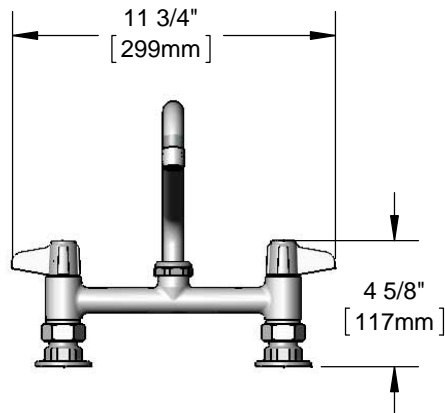
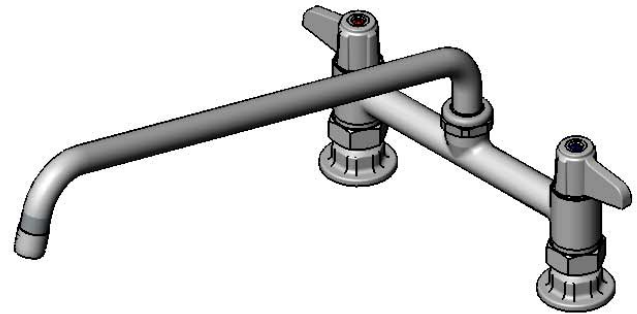

#### Features & Benefits:

- 8" deck mount mixing faucet with polished chrome plated brass body
- 16" equip swing nozzle w/ laminar full flow device
- Quarter-turn ceramic cartridges
- equip lever handles w/ color coded screws
- 1/2" NPT female inlets w/ Ø 2" flanges
- Adjustable centers from 7 3/4" to 8 1/4"
- Material: Polished chrome plated brass body & tubular spout and chrome plated metal handles

#### Product Compliance:

- ASME A112.18.1 / CSA B125.1
- NSF 61 - Section 9
- NSF 372 (Low Lead Content)
- ANSI A117.1 (ADA)

**Warranty:** One Year (Limited)

#### Performance Data:

- Pressure: 20 - 125 psi
- Temperature: 40 °F - 140 °F
- Flow Rate: 5.23 GPM @ 60 psi



ADA Compliant



equip Foodservice Accessories



• 2 Saddleback Cove • Travelers Rest, SC 29690  
Ph 800-891-4808 • Fax 800-868-0084  
www.tsbrass.com

Date: 10/24/16