



Swivel Sink and Pantry Faucets

B-0268-04

TAG:

Double Pantry Faucet

Architect/Engineering Specifications:

Single hole deck mount mixing faucet with polished chrome plated brass body, 24" double joint swing nozzle with stream regulator outlet, compression cartridges with spring checks, lever handles, 7 5/8" swivel extension and 18" flexible stainless steel supply hoses w/ 1/2" NPSM / 5/8" O.D. compression connections. ASME A112.18.1 / CSA B125.1, NSF 61-Section 9 and NSF 372. Meets ADA ANSI/ICC A117.1 requirements.

Job Name _____
 Model Specified _____ Quantity _____
 Variations Specified _____
 Date _____

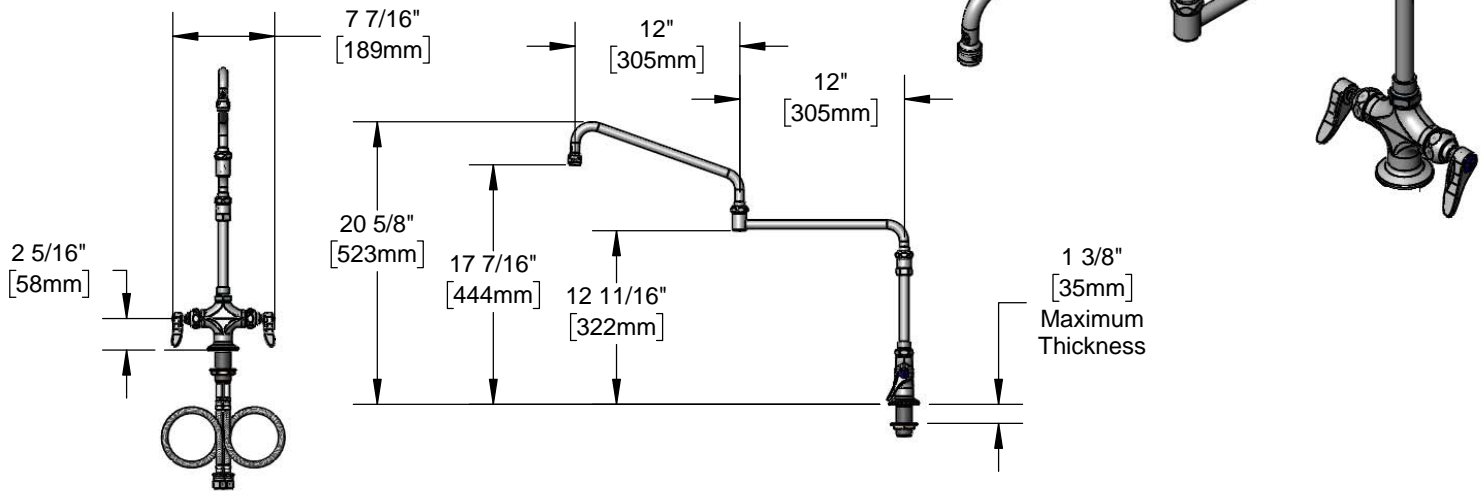

Features & Benefits:

- Single hole deck mount mixing faucet w/ polished chrome plated brass body
- 24" double joint swing nozzle with 12" front and back nozzles
- Stream regulator outlet, Series 1
- Quarter-turn Eterna compression cartridges w/ spring checks to prevent the cross flow of water
- Lever handles w/ color coded indexes
- 7 5/8" straight swivel extension
- 18" flexible stainless steel supply hoses w/ 1/2" NPSM / 5/8" O.D. compression connections
- Material: Polished chrome plated brass body & tubular spout and polished chrome metal handles

Product Compliance:

- ASME A112.18.1 / CSA B125.1
- NSF 61 - Section 9
- NSF 372 (Low Lead Content)
- ANSI A117.1 (ADA)

Warranty: One Year (Limited)

Performance Data:

- Pressure: 20 - 125 psi
- Temperature: 40 °F - 140 °F
- Flow Rate: 8.67 GPM @ 60 psi



ADA Compliant

Optional Outlets (Series 1 / VR Series 6)

GPM	Aerated	Non-Aerated (Laminar)	VR Aerated	VR Non-Aerated (VR Laminar)	Optional Handles
0.35	N/A	<input type="checkbox"/> B-0199-01-N035	N/A	<input type="checkbox"/> B-0199-06-N035	<input type="checkbox"/> 4" Wrist Action
0.5	N/A	<input type="checkbox"/> B-0199-01-N05	N/A	<input type="checkbox"/> B-0199-06-N05	<input type="checkbox"/> Lever (Standard)
1.0	<input type="checkbox"/> B-0199-01-F10	N/A	<input type="checkbox"/> B-0199-06-F10	N/A	<input type="checkbox"/> 4-Arm
1.2	<input type="checkbox"/> B-0199-01-F12	<input type="checkbox"/> B-0199-01-LF12	<input type="checkbox"/> B-0199-06-F12	<input type="checkbox"/> B-0199-06-LF12	Optional Cartridges With Checks
1.5	<input type="checkbox"/> B-0199-01-WS	<input type="checkbox"/> B-0199-29	<input type="checkbox"/> B-0199-06-WS	<input type="checkbox"/> B-0199-29VR	<input type="checkbox"/> Quarter-Turn Cerama w/ Check Valve
2.2	<input type="checkbox"/> B-0199-01	<input type="checkbox"/> B-0199-21	<input type="checkbox"/> B-0199-06	<input type="checkbox"/> B-0199-21-VRF	<input type="checkbox"/> Quarter-Turn Eterna w/ Spring Check (Standard)



T&S BRASS AND BRONZE WORKS, INC.



• 2 Saddleback Cove • Travelers Rest, SC 29690
 Ph 800-476-4103 • Fax 864-834-3518
 • Simi Valley, CA • Ph 800-423-0150 • www.tsbrass.com

Date: 05/05/17