

*This Space for Architect/Engineer Approval*

Job Name \_\_\_\_\_ Date \_\_\_\_\_

Model Specified \_\_\_\_\_ Quantity \_\_\_\_\_

Customer/Wholesaler \_\_\_\_\_

Contractor \_\_\_\_\_

Architect/Engineer \_\_\_\_\_

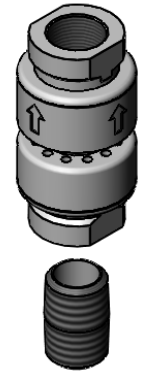
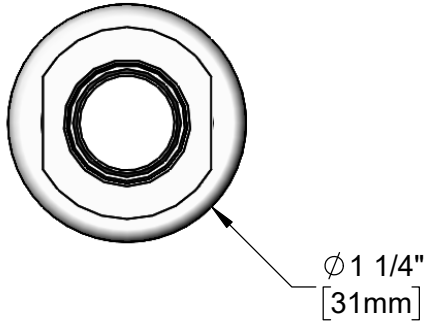

3/8" NPT  
Female Outlet

B-0970-FE  
Vacuum Breaker

2 3/8"  
[60mm]

3/8" NPT  
Female Inlet

3/8" NPT Male  
Close Nipple

1 1/16"  
[26mm]

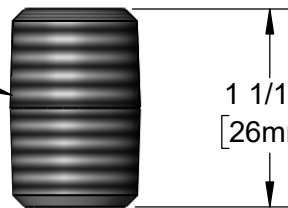
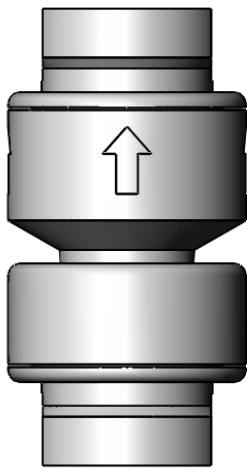

Model Number

**5PR-VB**

Product Specifications:

**Dual Check Vacuum Breaker with Intermediate Vent, 3/8" NPT Female Inlet & Outlet (for Continuous Pressure Applications) w/ 3/8" NPT Close Nipple**

Product Compliance:

ASME A112.18.1 / CSA B125.1  
NSF 61 - Section 9  
NSF 372 (Low Lead Content)  
CSA B64.8 (VB)

equip  
Foodservice  
Accessories

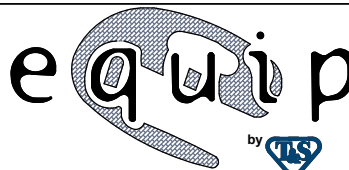

2 Saddleback Cove, P.O. Box 1088  
Travelers Rest, South Carolina 29690  
Phone: 800.891.4808 Fax: 800.868.0084  
equip.tsbrass.com

ITEM NO.	SALES NO.	DESCRIPTION
1	B-0970-FE	3/8" NPT Vacuum Breaker
2	002535-25	3/8" NPT Close Nipple

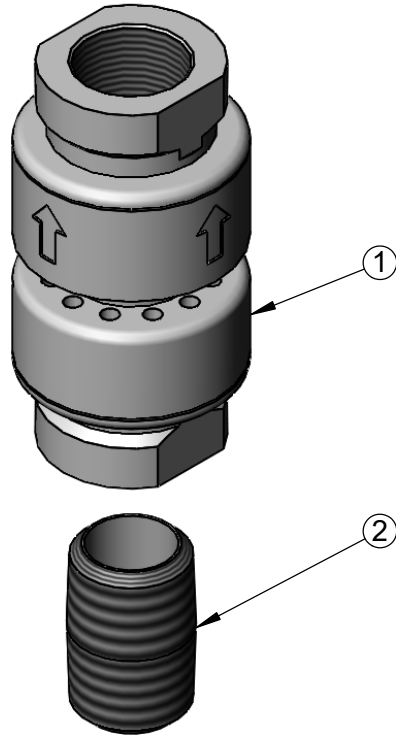

<p>Model Number</p> <p><b>5PR-VB</b></p>	<p>Product Specifications:</p> <p>Dual Check Vacuum Breaker with Intermediate Vent, 3/8" NPT Female Inlet &amp; Outlet (for Continuous Pressure Applications) w/ 3/8" NPT Close Nipple</p>				
<p>Product Compliance:</p> <p>ASME A112.18.1 / CSA B125.1  NSF 61 - Section 9  NSF 372 (Low Lead Content)  CSA B64.8 (VB)</p>	<p>equip  Foodservice  Accessories</p>  <p>2 Saddleback Cove, P.O. Box 1088  Travelers Rest, South Carolina 29690  Phone: 800.891.4808 Fax: 800.868.0084  equip.tsbrass.com</p>				
<p>Drawn: JDR</p>	<p>Checked: JRM</p>	<p>Approved: JHB</p>	<p>Date: 06/14/22</p>	<p>Scale: NTS</p>	<p>Sheet: 2 of 2</p>