



Spray Valve Assemblies

B-0101-A84

TAG:

Spray Valve with Hose

Architect/Engineering Specifications:

Push button spray valve with polished chrome plated brass body, 2.2 GPM aerator, 84" flexible stainless steel hose and 1/2" NPT male inlet. Certified to ASME A112.18.1/CSA B125.1, NSF 61-Section 9 and NSF 372.

Job Name	_____		
Model Specified	_____	Quantity	_____
Variations Specified	_____		
Date	_____		

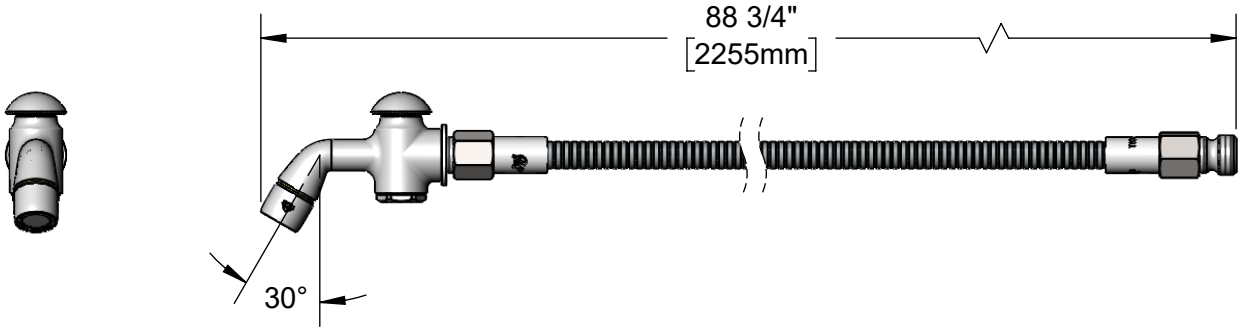
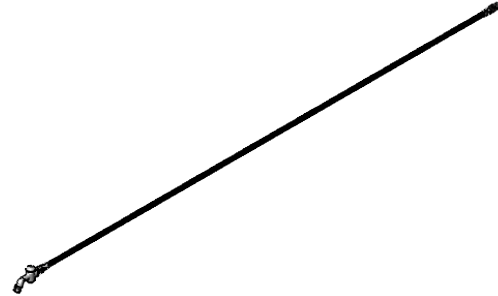

Features & Benefits:

- Push button spray valve
- 2.2 GPM aerator, Series 2 (B-0199-02)
- 84" flexible stainless steel hose
- Stainless steel washer for use with B-KF deck flange
- 1/2" NPT male inlet
- Material: Polished chrome plated brass body and stainless steel hose

Product Compliance:

- ASME A112.18.1 / CSA B125.1
- NSF 61 - Section 9
- NSF 372 (Low Lead Content)
- EPA Act 2005 Non-Compliant (PRSV)
- Product Not Designed/Intended for Commercial Warewashing in North America



Warranty: One Year (Limited)

Performance Data:

- Pressure: 20 - 125 psi [1.38 - 8.62 bar]
- Temperature: 40°F - 140°F [4.44°C - 60°C]
- Flow Rate: 2.2 GPM [8.3 L/min] @ 60 psi [4.14 bar]

Optional Outlets (Series 2 / VR Series 7)

GPM	Aerated	Non-Aerated (Laminar)	VR Aerated	VR Non-Aerated (VR Laminar)
0.35	N/A	<input type="checkbox"/> B-0199-02-N035	N/A	<input type="checkbox"/> B-0199-07-N035
0.5	N/A	<input type="checkbox"/> B-0199-02-N05	N/A	<input type="checkbox"/> B-0199-07-N05
1.0	<input type="checkbox"/> B-0199-02-F10	N/A	<input type="checkbox"/> B-0199-07-F10	N/A
1.5	<input type="checkbox"/> B-0199-02-WS	N/A	<input type="checkbox"/> B-0199-07-WS	N/A
2.2	Standard	N/A	<input type="checkbox"/> B-0199-07	N/A



T&S BRASS AND BRONZE WORKS, INC.



• 2 Saddleback Cove • Travelers Rest, SC 29690
 Ph 800-476-4103 • Fax 864-834-3518
 • Simi Valley, CA • Ph 800-423-0150 • www.tsbrass.com

Date: 09/06/23