

Architect/Engineering Specifications:

8 1/8" swing nozzle with polished chrome plated brass tubular body and 2.2 GPM aerator. Certified to ASME A112.18.1/CSA B125.1, NSF 61-Section 9 and NSF 372.

Job Name _____
 Model Specified _____ Quantity _____
 Variations Specified _____
 Date _____

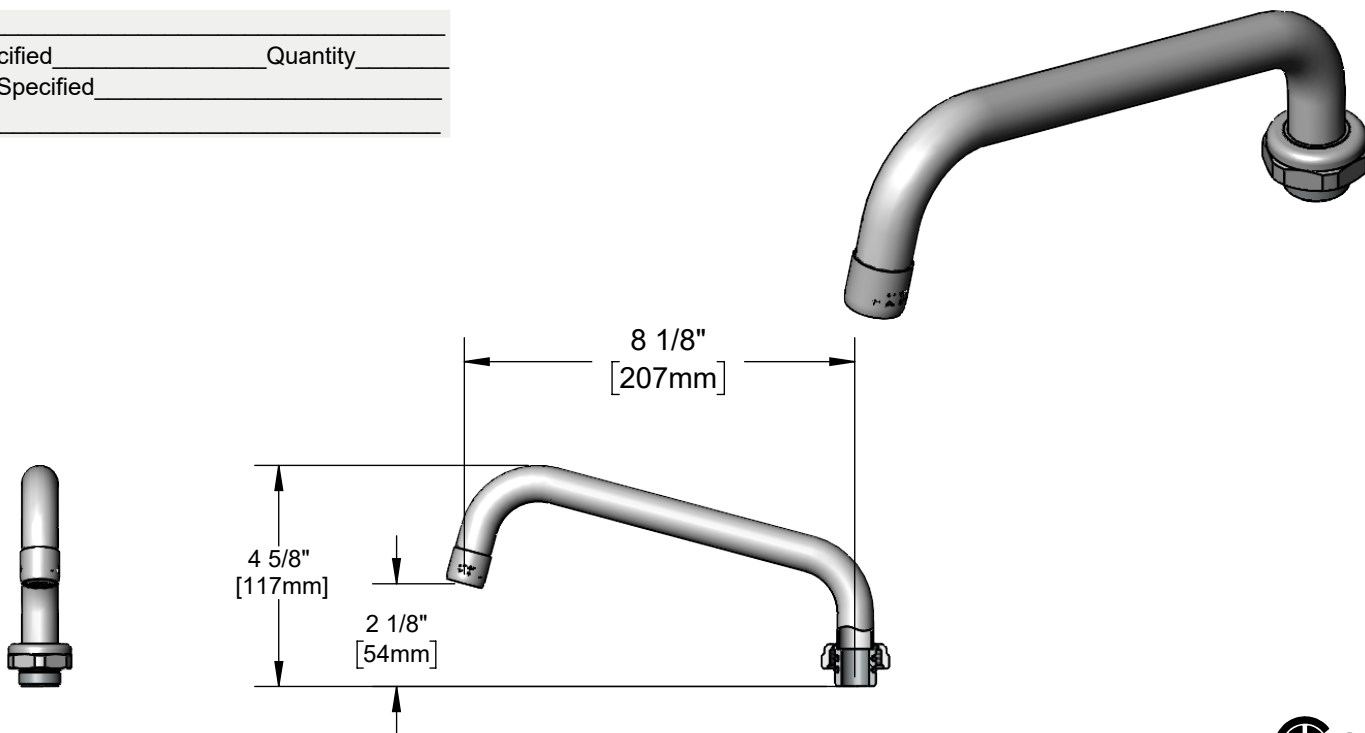

Features & Benefits:

- 8 1/8" swing nozzle
- 2.2 GPM aerator
- Fits all equip swivel outlet faucets
- Material: Chrome plated brass tubular spout

Product Compliance:

- ASME A112.18.1 / CSA B125.1
- NSF 61 - Section 9
- NSF 372 (Low Lead Content)
-

Warranty: One Year (Limited)

Performance Data:

- Pressure: 20 - 125 psi [1.38 - 8.62 bar]
- Temperature: 40°F - 140°F [4.44°C - 60°C]
- Flow Rate: 2.2 GPM [8.3 L/min] @ 60 psi [4.14 bar]