



Architect/Engineering Specifications:

Chrome plated brass 1 1/4" Nipple with 3/8" NPT male threads. Certified to NSF 61-Section 9 and NSF 372.

Job Name \_\_\_\_\_

Model Specified \_\_\_\_\_ Quantity \_\_\_\_\_

Variations Specified \_\_\_\_\_

Date \_\_\_\_\_

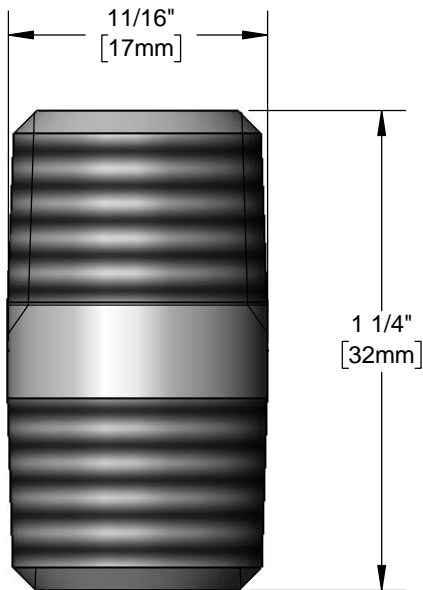
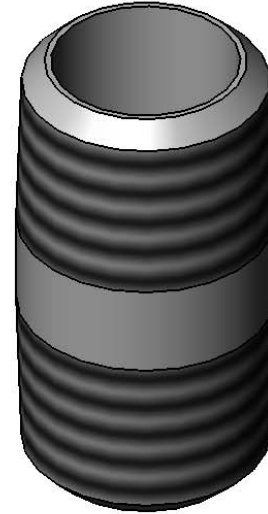

Features & Benefits:

- Chrome plated 1 1/4" Nipple
- 3/8" NPT male threads (both ends)
- Material: Chrome plated brass

Product Compliance:

- NSF 61 - Section 9
- NSF 372 (Low Lead Content)



Warranty: One Year (Limited)

Performance Data:

- N/A

