



**T&S BRASS AND BRONZE WORKS, INC.**  
 2 Saddleback Cove / P.O. Box 1088  
 Travelers Rest, SC 29690

Model No.  
**055A**

Item No.

Travelers Rest, SC: 800-476-4103 • Simi Valley, CA: 800-423-0150 • Fax: 864-834-3518 • www.tsbrass.com

This Space for Architect/Engineer Approval

Job Name \_\_\_\_\_ Date \_\_\_\_\_

Model Specified \_\_\_\_\_ Quantity \_\_\_\_\_

Customer/Wholesaler \_\_\_\_\_

Contractor \_\_\_\_\_

Architect/Engineer \_\_\_\_\_

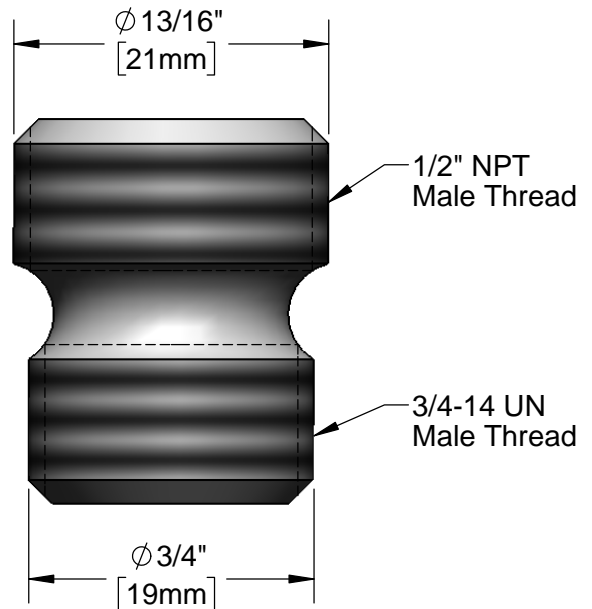
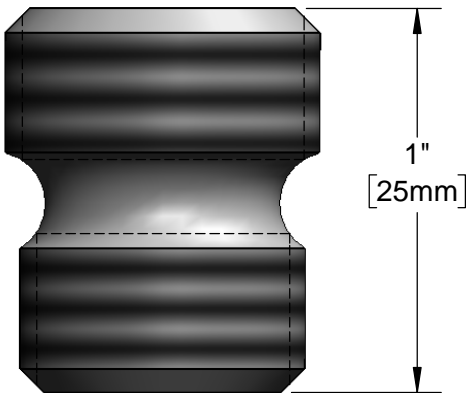
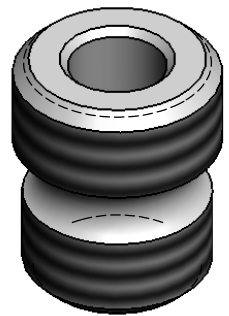
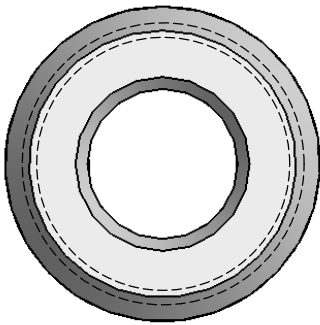

Product Specifications:  
 1/2" NPT Male x 3/4-14 UN Male Adapter

Product Compliance:  
 NSF 61 - Section 9  
 NSF 372 (Low Lead Content)